



MANUAL
WORKING ENVIRONMENT FOR BUILDING
AND CONSTRUCTION
2020

MANUAL

WORKING ENVIRONMENT FOR BUILDING
AND CONSTRUCTION

2020

Manual - working environment in building
and construction 1st edition, 1st edition 2020
© 2020 Trade working environment council for Building and Construction
Editorial staff, completed April 2020

Product number: **13 22 41**

ISBN: **978-87-7952-306-7**

Illustrations: Kristof Bien & Lars-Ole Nejstgaard

Layout / DTP: FINGERSPITZ *

Production: Praxis

Print: ScanPrint

This manual provides guidance on good working environment management practices in the construction and civil engineering industry. It provides guidance on how to comply with the regulations of the Working Environment Act.

The manual has been published by the Industry Community for the Working Environment in Building & Construction (BFA Construction) with technical assistance from the Danish Working Environment Authority's experts in the field of construction and civil engineering. It is primarily designed for companies and employees, including the working environment organisation, but can also be used by project planners, consultants, the client's coordinators, safety managers, teachers, suppliers and others who have an influence on the industry's working environment.

In this manual, we have included a number of pages  that refer to guidelines, films, etc. on our website on the same topic. At www.bfa-ba.dk you can download the handbook electronically and, of course, our other materials about the working environment.

Sign up for our newsletter at www.bfa-ba.dk and receive automatic notifications when new guides etc. are sent out.

This issue from 2020 has been updated with the latest information.

The Danish Working Environment Authority has reviewed the Manual and confirms that the content, including text and images, relating to working environment conditions comply with the requirements set out in the working environment legislation.

The Danish Working Environment Authority has only assessed the Manual as it exists and points out that there may be working environment issues and requirements that have not been dealt with in the Handbook. The Danish Working Environment Authority has reviewed the Manual in accordance with the rules and practice in June 2020.

WORKING ENVIRONMENT ACT

The Working Environment Act	9
The working environment system	10
The Working Environment Authority	12
Responses from the Working Environment Authority	13
The Smiley system	18
Working environment obligations and liabilities	19
Employers	19
Management	20
Supervisors	20
Employees	21
Suppliers	21
Project planners and consultants	22
Developers	23
Health and Safety Plan (PSS)	31
Working environment advice	34
The working environment organisation within companies	34
Safety meetings on building and construction sites	40
Working environment work on building and construction sites	40
Election of working environment representatives	41
Supervisors	42
Working environment training	43
Workplace assessment	46
Minors under 18	48
Industrial injuries	50

SITE LAYOUT

Site layout	57
Access routes.....	61
Site hut facilities	66
Stationary workplaces.....	74
Working on roofs.....	75
Fall prevention.....	83
Lighting	90
Electricity.....	92
Water pipes.....	98
Waste	98
Winter measures.....	99

CRANES, LADDERS AND SCAFFOLDING

Working at heights	103
Facade scaffolding	103
Working on scaffolding	110
Rolling scaffolding.....	114
Trestling	116
Work platforms, 1- and 2-pillar	118
Personnel lifts/telescopic loaders with baskets	125
Personnel lift with crane basket.....	128
Ladders	129
Lifting and hoisting equipment	133
Cranes.....	138
Tower cranes	143
Mobile cranes and other moving cranes	147
Fork lifts.....	148
Loading and transport machinery.....	148
Construction site lifts, transport platforms and material hoists.....	149

MACHINERY AND TOOLS, GENERAL

Machinery and tools in general	155
Machinery for concrete and mortar	163
Machinery for wood	165
Machinery for metal	169
Motorised hand tools	170
Electric hand tools	172
Powder-actuated tools	177
Compressed air systems and tools	181
Pressurised cylinders	186

NOISE AND VIBRATIONS

NOISE	189
VIBRATION	191

CHEMICALS AND DUST

Chemicals and dust	197
Chemical risk assessment	198
STOP principle	199
Substitution	200
Limits and measurements	202
Classification and labelling	203
H and P phrases	204
Toxic substances and products	204
Code numbering	205
Painting	207
Organic solvents	208
Cleaning wallpaper	210
Impregnated timber	210
Form oils	211
Epoxy and isocyanates	213
Asphalt (bitumen)	216
Dust	219

Vacuum cleaners	220
Asbestos.....	221
Mineral wool and other insulation materials.....	227
Quartz dust.....	229
Wood dust.....	230
Welding and cutting smoke	231
Fly ash.....	232
Cement.....	232
Lead.....	233
Soil contaminated with oil and chemicals.....	236
PCBs	238
Chlorinated paraffins	241
Biological impact	242

LIFTING AND WORKING POSITIONS

Lifting and working positions	245
Working positions	255
Technical aids	260
Cold and heat	262

WORK PROCESSES

Excavation work	265
Gas pipes	273
Construction work near to water	274
Roadworks.....	278
Demolition	287
Renovation.....	290
Removal of concrete.....	291
Precast panel installation	291
Crawl spaces, attics and roof spaces.....	298
Working in enclosed spaces and gullies	301
Hot work.....	305
Welding and cutting.....	309
Lasers.....	315

MENTAL HEALTH

Mental health.....	317
--------------------	-----

PROTECTIVE EQUIPMENT

General information on personal protective equipment.....	323
Helmets.....	326
Ear defenders	328
Eye protection	331
Respiratory protection.....	332
Fall protection	340
Protective clothing.....	347
Gloves.....	348
Protective footwear	350

THE WORKING ENVIRONMENT ACT

Working environment legislation includes rules specifying requirements for the working environment which must be observed by enterprises and on building sites. The objective is to ensure a safe working environment for all enterprises and on all building sites.

Working environment legislation comprises the Working Environment Act and a number of Executive Orders which expand upon and detail the regulations in the Act.

The rules in the working environment legislation explain the objectives of securing a good working environment but do not discuss the methods and means of achieving this goal. It is thus the individual company's responsibility to decide what needs to be done and implemented in order to comply with working environment legislation.

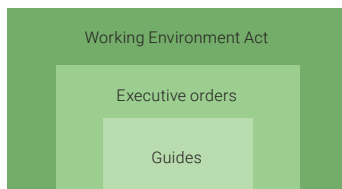

Executive Orders

A more detailed description of the requirements for the working environment can be found in the Executive Orders. These include, for example:

- Executive Order on Building and Construction
- Executive Order on the Obligations of the Client
- Executive Order on Asbestos
- Executive Order on noise
- Executive Order on the use of technical equipment
- Executive Order on the use of personal protective equipment

The Danish Working Environment Act and related executive orders must be followed by all of the construction project's players: employers, supervisors, employees, developers, designers, consultants, suppliers, etc.

1. THE WORKING ENVIRONMENT ACT AND SAFETY WORK

It is an offence to fail to comply with the Working Environment Act and Executive Orders, and violations may lead to fines or imprisonment.

Guides

At-guides

A WEA guideline, WEA directive or WEA notice has been issued by the Danish Working Environment Authority and provides guidance on how the rules in the Danish Working Environment Act and the executive orders are to be interpreted and understood, as well as on which practices apply in relation to compliance with the rules. An WEA guideline contains a description of the most important health and safety rules in an area. The guidelines describe how companies can comply with the rules. Methods other than those described in the instructions may be used, but the level of safety must be at least the same. The guidelines will always clearly state when there is a binding method requirement in an area.

The Danish Working Environment Act, Executive Orders, WEA guidelines and other information material from the Danish Working Environment Authority can be found at www.at.dk

Industry Guides

Industry guides describe good industry practice that has been agreed between trade unions and employer organisations (the parties within the building and construction sector). The guidelines contain specific recommendations for companies. They have been prepared by the Trade Community for the Working Environment in Building & Construction (BFA Building & Construction) or another trade community and have been reviewed by the Working Environment Authority. Following the industry guidelines' recommendations, confirms compliance with the working environment legislation for the area described in the guidelines. Industry guides for building and construction can be found at www.bfa-ba.dk

THE WORKING ENVIRONMENT SYSTEM

Four important players influence the development of new rules and the interpretation of the Working Environment Act and applicable rules. These are:

- Authorities (the Ministry of Employment and the Danish Working Environment Authority) that administer the Act, issue Executive Orders and supervise that enterprises comply with the working environment legislation.
- The partner system (the Danish Working Environment Council and the 5 trade associations for working environment), which consists of representatives from the trade unions and from the organisations of managers and employers. The industrial partner system is involved in amendments to working environment legislation and promotes good working environment practice among enterprises' managers and employees.
- The Danish Working Environment Appeals Board, which deals with complaints concerning the Danish Working Environment Authority's decisions. The NCP is independent of the Ministry of Employment and the Danish Working Environment Authority. The chairman and the members are appointed by the Minister for Employment - the organisations appoint members who are formally approved by the Minister for Employment.
- The courts, that take the final decision in criminal proceedings.

According to the Working Environment Act, other institutions may also assist enterprises with preventing working environment problems.

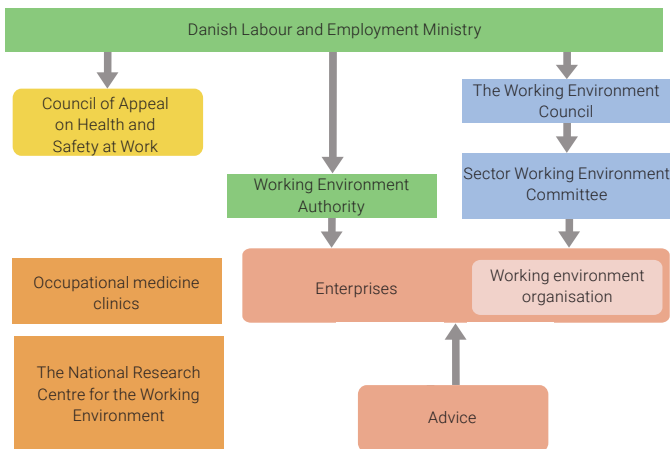

1. THE WORKING ENVIRONMENT ACT AND SAFETY WORK

- The working environment organisation is the enterprise's own working environment unit, which its management can involve in preventive working environment work.
- The occupational medicine clinics and departments at the hospitals can investigate whether conditions or illnesses are due to the work. These clinics can also work in cooperation with enterprises to help prevent injury.
- The National Research Centre for the Working Environment (NFA) carries out research and development projects that can help authorities, parties and companies investigate and map working environment problems and develop better methods to prevent them.
- Authorised working environment advisors approved by the Danish Working Environment Authority can help companies to map and solve working environment problems.
- Construction Working Environment Bus (Bam-Bus). Companies and employees covered by the Construction Working Environment Bus (Bam-Bus) consultancy scheme are free to use this scheme for guidance on specific issues. See more: www.bam-bus.dk.

THE WORKING ENVIRONMENT AUTHORITY

The Working Environment Authority must contribute to promoting a safe, healthy and developing working environment, preventing occupational injuries and wear and tear, as well as preventing sickness absence and exclusion from the labour market. Specifically, this is achieved by:

- supervising the enterprise's working environment;
- developing rules;
- providing guidance on working environment.

The Working Environment Authority conducts inspection visits to check that the companies comply with the working environment legislation. If the rules are not complied with, the Working Environment Authority will issue decisions (e.g. enforcement notices) and/or provide guidance to companies on how best to comply with the rules.

Enterprises may not deny the Working Environment Authority access to a workplace or building site.

As an employee, you can contact the Danish Working Environment Authority and complain about the working environment without the manager or colleagues being informed. Staff at the Working Environment Authority must not indicate whether they are making an supervisory visit to an enterprise following a complaint.

Response by the Working Environment Authority

If the Working Environment Authority discovers violations of working environment legislation during the supervision of the enterprise, the Working Environment Authority may issue various types of decisions. Typically within building and construction, there will be orders with deadlines, immediate enforcements, investigation orders, decisions without obligation to act and prohibitions.

The Danish Working Environment Authority's enforcement notices with deadlines, immediate enforcement notices, investigation orders, decisions without obligation to act and prohibitions are issued in writing. Guidance may be provided both verbally and in writing.

About the individual reactions

- **Prohibitions** are issued in the event of infringements where the danger is imminent and significant and no further work must be carried out until the problem has been resolved. Prohibitions are issued by making a decision on the spot.
- **Immediate enforcement notices** mean that the company must immediately initiate a solution to the working environment problem. Immediate enforcement notices shall be issued in the event of infringements where:
 1. the danger is significant enough that it must be dealt with immediately, although the danger may not be imminent;
 2. the purpose of the decision will be lost if no immediate action is taken;
 3. an order can actually be complied with immediately or within a short period of time;

1. THE WORKING ENVIRONMENT ACT AND SAFETY WORK

Immediate enforcement notices are issued by making a decision on the spot.

- **Orders with deadlines** are issued in the event of infringements that are not immediately resolved at the time of the visit, and the company is given a deadline to ensure a good solution. The enforcement notice is sent to the enterprise within 14 days of the supervisory visit. The problem must be resolved within the given deadline.
- **Guidance** is given when it is relevant to advise the company on applicable rules and where the Working Environment Authority does not find a basis for making a decision. This is not a direct demand on the enterprise, merely guidance on the regulations in the field.
- **Examination injunctions:** The company may be subject to an investigation order if the Danish Working Environment Authority has a concrete suspicion that the working conditions are unsafe in terms of health and safety.

This order requires the enterprise to carry out investigations, take samples or carry out inspections in order to ascertain whether the working conditions are good.

If the company is ordered to investigate the psychological working environment or to investigate the possibilities of substituting substances and materials, the examination must be carried out by an authorised consulting firm in the field of working environment.

- **Decision without obligation to act:** This is used when, during a supervisory process, the Danish Working Environment Authority discovers a violation of the working environment legislation that does not lead to an immediate enforcement notice or prohibition, and the enterprise has either already resolved the working environment problem, e.g. in connection with the Working Environment Authority investigating an occupational accident, or the enterprise solves the problem before the inspection has been completed.

A decision without obligation to act is also made when the project planner has violated the rules for planning and design and the construction process cannot be changed with an order.

- **Advisory injunctions:** The Working Environment Authority may also issue an advisory injunction in connection with an injunction. This means that the company must use an authorised working environ-

ment advisor to help solve and prevent the problems that the company has been ordered to solve. This type of enforcement notice will be replaced by so-called competency enforcement notices in 2021. See more at at.dk.

- **Advice for developers:** When the Working Environment Authority believes that a developer has failed to meet its obligation to produce a "Health and Safety Plan" or if there are significant flaws in the plan.

Feedback to the Working Environment Authority

An enterprise that has received an order or prohibition must report back to the Working Environment Authority's digital self-service solution on the Working Environment Authority's website (advi) on how this has been complied with. In its response, the employer must declare that the working environment organisation/a representative of the employees has been made aware of the content of the feedback.

The Working Environment Authority should always be able to provide grounds for its enforcement notices and prohibitions with reference to the Working Environment Act or Executive Orders.

Enterprises wishing to appeal against the Working Environment Authority's enforcement notices must send their appeals to the Working Environment Authority at the latest within four weeks of receiving the Working Environment Authority's initial decision. If the Working Environment Authority maintains its decision, the case is forwarded to the Working Environment Appeals Board.

Administrative fines

The Danish Working Environment Authority may issue administrative fines. This means that the recipient can pay the fine without the violation being reported to the police. The Danish Working Environment Authority may issue administrative fines if the infringement is clear and uncomplicated, if there is a clear legal practice in this area, and if the recipient of the fine has not opposed a decision in this way. If the aforementioned conditions are not met, the Working Environment Authority will instead send a report to the police.

Police report

A police report entails that the Danish Working Environment Authority sends the case to the police, who will investigate the case in more detail. The prosecutor then assesses whether there is a basis for imposing a fine on the company or the person concerned. The prosecutor may choose to send a fine to the person concerned. This is called an extrajudicial fine. If the person in question does not pay the fine, the prosecutor will send the case to the court. It is then the courts that make the final decision on the case. The prosecutor may also choose to send the case directly to the court without first having sent an extrajudicial fine.

Who can be given a fine?

The Working Environment Act provides for the possibility of penalising several different actors for breaking the law. Those that can receive penalties can generally be divided into two groups: employers and individuals. The majority of criminal cases for violations of the Working Environment Act are brought against employers. This can either be a so-called legal person, e.g. companies, associations and municipalities or owners of personally owned companies. Criminal proceedings against individuals may be employees, supervisors and company managers.

The Working Environment Authority may also bring criminal proceedings against other actors, such as developers, designers, suppliers and installers.

The employer's limited liability

In special circumstances, an employer may be exempt from penalty if an employee has committed a violation. This requires that the employer has done everything possible to ensure a safe and healthy working environment. The employer must do this by fulfilling all of its obligations in accordance with Chapter 4 of the Working Environment Act.

When the Working Environment Authority assesses whether the employer has fulfilled all of its obligations in accordance with Chapter 4 of the Act, emphasis is placed on:

- whether the employer has ensured that the specific working conditions are fully justifiable in terms of health and safety

- whether the employer has planned and organised the work so that it can be carried out in a completely responsible manner with regard to health and safety
- whether the necessary and suitable safety equipment is present and complies with the rules on design and use
- whether the employer has instructed its employees in how to perform the specific work safely
- whether the employer has effectively supervised that the work is actually carried out responsibly
- whether the employer has prepared a work place assessment
- whether the employer has ensured that there is a working environment organisation where this is required.

Employees

Employees may be penalised if they intentionally or grossly break the law. For example, this applies to the following areas:

- Use of personal protective equipment.
- Use of extraction measures.
- Use of protective equipment or safety measures.
- Use of responsible working methods
- Missing certificates for crane and forklift.

Holistic supervision

The Working Environment Authority employs several different forms of supervision when investigating the working environment in Denmark. Holistic supervision (HOT) is used for building and construction projects. This is the construction site inspection. However, there will also be companies in the industry that can be supervised in other ways, e.g. on the basis of the company's address. Read more about supervision and inspection at www.at.dk.

During construction site visits, the Working Environment Authority will arrive unannounced at the construction site. The inspection focuses on the entire construction site and the companies involved, as well as the

1. THE WORKING ENVIRONMENT ACT AND SAFETY WORK

responsibilities of the developer and, to the relevant extent, the responsibilities of the project planners. So the site as a whole is inspected and supervision is not only limited to individual specific areas of work.

If health and safety problems have been identified for which the Danish Working Environment Authority issues a ruling, the Working Environment Authority will follow up with meetings with the individual companies, participate in safety meetings or similar at the construction site and meetings with the project planners or developer. These meetings can then be followed up by new inspections, depending on the result of the meetings. Specifically, the method can be divided into the following forms of inspections and meetings:

- The purpose of the unannounced inspection by the Danish Working Environment Authority on the construction site is to increase the industry's compliance with the rules through the Danish Working Environment Authority's inspection and visibility on construction sites.
- Meetings with companies with specific working environment problems, intended to increase the companies' ability to prevent working environment issues through a motivational dialogue on planning and cooperation.
- Meetings with the various parties at the construction site, intended to increase health and safety in the planning and construction process, e.g. if there are problems with common areas or cooperation and prevention.
- Follow-up inspections at the companies' main office, intended to check the working environment at the main office, workshop or warehouse, etc. With construction sites, the aim is to check continued compliance with the rules.

The Smiley system

Companies receive a green, yellow or red smiley based on the Danish Working Environment Authority's decisions. A green smiley is awarded to companies when a thorough inspection considers the entire working environment and no working environment problems are found. The smiley is published on the Working Environment Authority website along with information on any enforcement notices which may have been issued to the company. Read more about the smiley scheme at www.at.dk.

WORKING ENVIRONMENT RESPONSIBILITIES AND LIABILITIES

Employers

The employer is responsible for ensuring that the enterprise is compliant with the Working Environment Act. In general, the Danish Working Environment Act requires the employer to ensure that work is planned, organised and carried out in a completely responsible manner in terms of health and safety.

Employers are obliged to ensure that:

- the workplace is organised in a fully responsible manner, e.g. to prevent falls and the risk of collapse
- employees are trained and have received instruction in their work in a fully responsible manner. The instruction and training is carried out in a language understood by the employees, possibly with the help of an interpreter
- employees are supervised effectively to ensure that they perform their work in a fully responsible manner and follow the instructions
- the necessary safety equipment is available and safe to use for the work in question
- the work can legally be carried out with personal protective equipment
- written work place assessments are prepared
- when there are 10 employees or more in the company and on construction sites with at least 5 persons (if the work lasts more than 14 days), a working environment organisation has been established
- the company's management must motivate the employees and ensure that the election of a working environment representative is made
- where several companies carry out work at the same time (e.g. on construction sites), there is cooperation between the companies and their employees
- there is participation in the developer's safety meetings with other employers and the working environment organisation at the construction site, where it must also be ensured that the decisions of the meeting are communicated to all the company's employees at the

1. THE WORKING ENVIRONMENT ACT AND SAFETY WORK

site - in the language understood by the employees, possibly with the help of an interpreter for those whose mother tongue is not Danish.

Company directors

If you are a director or otherwise part of the general management, you have the same obligations as the employer.

Supervisors

According to the Danish Working Environment Act, a supervisor is the person who manages or supervises the work on behalf of the employer.

The Working Environment Act states that the supervisor must contribute to ensuring that the working environment is in full compliance with the regulations within the area that the supervisor manages.

This means that the supervisor must ensure compliance with the working environment regulations e.g. that the safety measures work as intended, and also that any problems are rectified.

This also applies to issues that the supervisor does not have the authority to solve. These must be referred to the management and followed up on.

To a certain extent, the supervisor's role can extend beyond his or her own field of competence in the sense that as representative of the management, it is the supervisor's job to report and follow up on working environment issues that may arise.

In addition, the supervisor has the same responsibilities as other employees, e.g. with regard to the use of personal protective equipment.

And a member of a working environment organisation, the supervisor is obliged to participate in the development of the working environment.

Finally, the supervisor should be able to cooperate with other companies that have employees in the same location.

Employees

Employees share responsibility for ensuring a good working environment.

You have a responsibility to:

- ensure that the working conditions are fully complied with in terms of health and safety within their own area of work and the safety instructions from employers are followed
- ensure that safety measures function as intended, e.g. by using the personal protective equipment provided
- ensure that any safety measures that have been temporarily removed are put back in place, e.g. when a railing on a roof/opening in a building is temporarily removed in connection with the laying out of materials
- notify the company's health and safety organisation, supervisor or employer of any errors or omissions that cannot be rectified
- cooperate with the other companies and employees at workplaces (e.g. construction sites), where several companies carry out work simultaneously
- comply with the rules applicable to health and safety when working on the territory of a different company.

Suppliers

As a seller or leaser of machines and other technical equipment, or as a seller of chemicals and other substances and materials, you are responsible for ensuring that the goods delivered can be transported, stored and used without risk to health and safety.

Suppliers must ensure that:

- machines have the necessary protective equipment and are CE marked
- the user instructions that explain how to set up, use and maintain the equipment are provided in Danish
- the technical material supplied, e.g. scaffolding, is legal and suitable for the work for which they have been ordered

1. THE WORKING ENVIRONMENT ACT AND SAFETY WORK

- chemicals and other substances and materials can be used as intended without endangering safety or health, and that instructions for use are provided in Danish.

Project planners and consultants



As project planner of building and construction work, you have to ensure with your project instructions that the regulations in the working environment legislation can be complied with in connection with implementation of the project and the operation and maintenance of the completed construction.

As project planner and consultant:

- Your work must enable the contractor to carry out the individual works or work phases in a sequence so that the work can be undertaken safely in terms of health and safety. It is important to take into account the time necessary for completing individual work elements or phases.
- Project specifications must ensure that suitable technical equipment can be used when the handling of heavy loads during the execution of the project and for subsequent maintenance.
- Describe the particular risks and other special conditions in the building and construction project that are of importance to the safety and health of craftsmen and construction workers.
- Ensure that the project does not include substances or materials that can be replaced by less hazardous substances and materials.
- Inform the developer of the obligations he has under the Working Environment Act in the specific project, e.g.:
 - whether it can be expected that there will be more than one company on the construction site at the same time
 - whether it can be expected that more than 10 people will also be employed on the construction site at the same time
 - which preliminary studies should be carried out, e.g. on contaminated soil, PCB and asbestos
- contribute to the preparation of a HSP (Health and Safety Plan)

- ensure that the client's health and safety coordinators are involved in the preparation of the construction project in the project planner's considerations and gain access to the relevant parts of the project material
- ensure that it is also possible to comply with the working environment rules when the finished building or plant is to be repaired and maintained, and prepare a logbook for this.

Read more about the project planners' and consultants' obligations at www.byggeproces.dk and about technical aids at www.bygergo.dk.

Developers

The developer is the organisation that finances the building and construction work to be carried out.



According to working environment legislation, construction and civil engineering work is:

- Work performed in connection with the construction and alteration of buildings and structures, including construction work
- Construction and alteration of roads, tunnels, bridges, ports and similar facilities
- Excavation and earthworks in connection with building and construction projects
- Pipe and cable laying
- Repair and maintenance work on building and construction projects
- Demolition and dismantling of building and construction projects and parts thereof

If more than one company will be employed on the construction site at the same time during the course of the construction work, the client must ensure:

- that safety measures are defined in the communal areas in which employees from several companies carry out work or work
- coordinating for health and safety, both during design and execution.

1. THE WORKING ENVIRONMENT ACT AND SAFETY WORK

If there is/will be more than one company and more than 10 employees at the same time at the site, the client must also ensure:

- the appointment of a health and safety coordinator who has completed training for health and safety coordinators - both during project design and during execution
- that a Health and Safety Plan (HSP) is prepared and which is ready before the execution phase
- that a logbook is kept if there are special conditions regarding health and safety in connection with future repair and maintenance work in the finished building or facility
- that start-up meetings are held with the companies who are to carry out work on site and members of the construction site's health and safety organisation
- that safety meetings are held with all companies and working environment organisations on the construction site
- that safety rounds are made at least once every 14 days.

Furthermore, developers are responsible for helping to ensure that enterprises and their employees can carry out their work on the building site in a fully responsible manner in terms of health and safety. However, the developer may not transfer the legal responsibility for their obligations.

Boundaries of safety measures in shared areas

Shared areas are all the places on the construction site where several companies work at the same time.

When more than one enterprise is to carry out work on the building site at the same time, the developer must agree with the employers who is responsible for establishing, maintaining and removing scaffolding and work platforms, traffic and access routes, guard rails and covers, etc. on roofs and orientation lighting, etc. in shared areas. This also includes responsibility for e.g. snow clearance, cleaning and various inspections.

If more than ten persons will be employed on the construction site at the same time, the agreements must be specified in the site's Health and Safety Plan.

If, during the course of the work, it transpires that there are more shared areas, or different shared areas to those assumed or if, for example, there is a change of the enterprises responsible for arrangements in the shared areas, a new definition of boundaries and new agreements with the individual employers must be compiled.

Examples of shared areas may include:

- Work areas in which several enterprises will be working at the same time
- Traffic and access routes
- Site huts
- Material sites
- Waste sites
- Walkways
- Scaffolding
- Fencing and signage
- Orientation lighting
- Construction power with panels and sub-panels, as well as water supply to the construction site and site huts.

Registration of the building site to the Working Environment Authority

If the construction site is expected to be in operation for more than 30 days and more than 20 employees are working there at the same time, before work commences, the client must register the construction site with the Danish Working Environment Authority. The building site must also be registered if the anticipated amount of work on the building site exceeds 500 man-days.

1. THE WORKING ENVIRONMENT ACT AND SAFETY WORK

The developer must register the building site on a specific form in either electronic or hard-copy format. The application can be obtained via at.dk or www.virk.dk. A copy of the registration must be displayed in a visible location on the building site so all can see that the building site has been legally registered.

Notification to the municipality

The developer must also notify various tasks and facilities to the municipality before work commences.

This is applies to e.g.:

- Façade renovation, e.g. sandblasting.
- Surface treatment of freestanding structures.
- Demolition of buildings and other noisy and dusty activities.
- Asphalt plants.
- Facilities for the treatment of contaminated soil.
- Facilities for crushing building materials.

Coordination during planning phase



The developer must ensure that a working environment coordinator (P) is appointed when it is expected that more than one company will be employed on the construction site at the same time.

On behalf of the developer, the working environment coordinator (P) must prepare a Health and Safety Plan (HSP) if it is expected that at any given time during the construction phase there will be at least two companies working at the site that simultaneously employ more than 10 people.

Coordination will help to ensure:

- that sufficient time has been set aside to carry out the various works or phases of work.
- that appropriate planning has been carried out with a correct order of the various work tasks in relation to the architectural, technical and organisational solutions chosen.

- that the various work processes can be carried out using suitable technical equipment and with appropriate working positions.
- that there are the appropriate descriptions of driving and pedestrian routes on the site, regardless of weather conditions, e.g. drainage and snow clearance.

One example of technical selection may be when a decision is made for a roof structure to be complete before wall cladding is fitted. This will require special planning and agreements on what aids and access routes must be present on site at a given time.

One example of organisational choice may be the developer's choice of contract form (total, principal or individual trade contract) or the working environment organisation in the construction project.

Construction logbook

The developer must ensure that the working environment coordinator prepares a construction logbook that is adapted to the building or the facility's characteristics and which contains a list of any special health and safety issues that should be taken into account in connection with future work, e.g. repair or maintenance work.

The planning manager must provide a description of the characteristics of the building or facility (construction, design, prescribed materials, etc.), if this has an impact on health and safety when working on maintenance or repair of the building or facility in question.

The working environment coordinator and the planning manager can prepare a shared list/jlogbook.

The client is responsible for ensuring that the project planners and working environment coordinator cooperate on the working environment coordination of the project design. Coordination must ensure that the project material takes health and safety into account during the construction phase and during repair, modification and maintenance of the finished building. However, the project planner has complete responsibility for ensuring that the project documentation is formulated so that it complies with the Working Environment Act.

Working environment coordination on construction sites regardless of size



The client must ensure that a working environment coordinator is appointed if more than one enterprise is to be employed at the construction site at the same time at any given time during the construction phase.

The working environment coordinator must ensure that there is overall coordination of health and safety in relation to all the companies employed at the construction site, particularly in relation to work and traffic in the shared areas. The coordinator must also coordinate:

- Health and safety cooperation between all enterprises working on the construction site. This also applies to enterprises that follow one another on the building site.
- The various enterprises' use of the health and safety plan (HSP) if required
- The various enterprises' checks that the work is being carried out in accordance with the regulations agreed with the developer
- The working environment coordinator must thus coordinate the enterprises' checks that work processes are being implemented in accordance with the agreed guidelines in, for example, the following areas:
 - Order and cleanliness on the building site.
 - Good access to workplaces.
 - Handling of various building materials, e.g. ensuring that there are no cranes over work areas where personnel are working.
- Ensuring that enterprises maintain electricity cables and other installations on the building site and check them before they are commissioned, and then regularly thereafter.
- Ensuring that enterprises define and set up storage sites and locations for materials, particularly if hazardous substances or products are to be stored.
- Hazardous waste
- How construction waste is stored and removed

- Ensuring that enterprises adapt to the actual time to be spent on the various types of work or work phases as work on the building site progresses.
- Cooperation between employers and self-employed tradesmen.
- Interaction with the activities taking place on or close to the building site. For instance, residential or business properties may be inconvenienced by noise, dust, etc.

Read more about this at www.byggeporces.dk.

Coordination of health and safety at larger construction sites during the construction phase (more than 10 people at the same time)

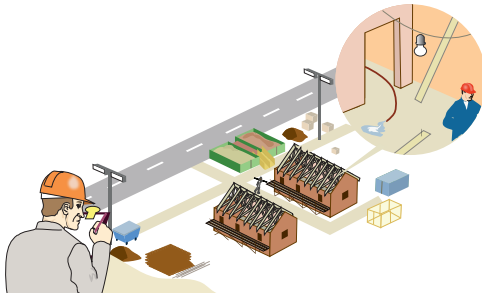

The client must ensure that the working environment coordinator on construction sites with more than one enterprise and more than 10 employees also:

- conducts start-up meetings with employers and members of the construction site's health and safety organisation. Employers who later enter into agreements to carry out work on the construction site must also be informed at a meeting with the working environment coordinator (B). The client must ensure that the contractors disclose information to the coordinator.e.g.: company name, address, telephone number and contact person, as well as which work each subcontractor must perform and how many employees they employ on the construction site.

1. THE WORKING ENVIRONMENT ACT AND SAFETY WORK

- Holds regular safety meetings at least once a fortnight, ideally in connection with the site meetings. The coordinator shall convene the safety meeting between employers and members of the working environment organisation at the construction site. All subcontractors must also be invited and participate. The working environment coordinator may convene extraordinary meetings as required, e.g. following serious accidents, poisoning incidents or near-accidents or poisoning.
- Chairs the safety meetings and is responsible for ensuring that the minutes are sent to the meeting's participants, the developer, all supervisors, the enterprises involved, the members of the working environment organisation and any shop stewards.
- Carry out safety rounds at least once every 14 days at the site. At the developer's safety meetings, the principles for how the safety rounds are conducted and who is to participate in the rounds will be determined.

The working environment coordinator must check, by personal contact and presence on the building site, that there is compliance with the agreements between the developer and the employers, and that cooperation on safety in shared areas is working.

The coordinator must also check that employers and others are complying with decisions from the safety meetings.

Employers on the building site must take into account the instructions of the working environment coordinator. For example, if the employer uses noisy machinery in a shared area, the coordinator may ask him to use less noisy machinery in order to reduce the noise. However, the employer can choose another way of reducing noise. And therefore does not need to follow the method specified by the coordinator. Such specific risks must be discussed regularly at the safety meetings, so - for example - noisy and dusty work is planned and organised so that other people on the construction site are not subjected to unnecessary stresses or health risks.

The working environment coordinator must ensure - and check - that only the enterprises and people who are working on the site (cf. the approved schedule) have access.

Health and Safety Plan (HSP)

A Health and Safety Plan (HSP) should ensure that everyone on the building site has a good working environment. At the same time, the plan can act as a useful control tool for the construction management team.



The developer must always prepare a HSP if more than 10 people are working at the same time at the site from more than one company. For small construction sites, a HSP need only be prepared when the work is particularly hazardous (see page 33).

HSP must be ready no later than when construction begins on the site. The developer is responsible for ensuring that the HSP is kept up-to-date as work on the construction site progresses. This applies in particular to the organisational plan, construction site plans and time schedule. All personnel on the construction site must be able to see the HSP, which must therefore always be available.

The HSP must include:

1. organisation plan
2. construction site plans
3. a time schedule
4. a plan of the traffic areas
5. an indication of the areas where several enterprises and their personnel will be working and the health and safety measures established in shared areas
6. the boundaries of areas where work may present a particular risk
7. a procedure for ongoing checks of installations, safety arrangements, any particular risks, etc.
8. an indication of who is to carry out any planned regular inspection and coordination of emergency, evacuation and emergency exercise plans

1. THE WORKING ENVIRONMENT ACT AND SAFETY WORK

9. specific arrangements relating to any particularly hazardous work.

The organisation chart consists of a list of the involved parties with relevant information about the individual contractor, including CVR number or RUT number, address and relevant telephone numbers, name list of contact persons, other telephone list, diagram with the construction site's health and safety organisation and a section with the individual persons' tasks.

The construction site plan must show where and what these risks are on the site, including the positioning of:

- access, transport and escape routes
- crane, hoist and scaffolding
- the designated location for material depots, temporary workshops and waste containers
- dedicated space for welfare measures
- connection to electricity, water and sewer
- alarm, fire, rescue and first aid equipment.

The time schedule must specify:

- when the individual employer has tasks on the construction site and how much time is allocated for the individual tasks or work phases,
- periods in which particularly hazardous work is to be undertaken (see list of particularly hazardous work below).

Shared areas and boundaries

There must be a description of where shared areas are located. The definition of responsibility for safety measures in the common areas must also be described.

There must be a specification of the shared safety arrangements. For example, a list can be compiled of the individual arrangements over the period to which the responsibility applies and which enterprise holds responsibility.

A HSP must be prepared for all construction sites where more than one company is working at the same time - also for those construction sites with less than 10 employees at the same time - for work that is listed as being particularly hazardous.

List of particularly hazardous work:

Risk of accidents

Work where employees run a particularly serious risk of being buried, sinking or falling.

Chemicals

Work which exposes employees to chemical or biological substances which pose a particular health and safety risk, or where the Act requires a health check.

Radiation

Work that exposes employees to ionising radiation and that makes it necessary to designate controlled and monitored areas.

Other

- Working near high-voltage lines
- Work involving a risk of drowning
- Work in wells and tunnels and underground work
- Underwater work with diving equipment
- Work in pressure chambers.
- Work which involves using explosives.
- Installation and removal of heavy prefabricated elements.

It may also be necessary to make a HSP when working in the vicinity of highly trafficked areas if the work is considered to be particularly hazardous.

Download the HSP guide on www.byggeproces.dk.

The employer must prepare a written assessment of the particularly hazardous work before it is carried out.

WORKING ENVIRONMENT ADVICE

Companies can benefit from involving authorised health and safety consultants in their preventive health and safety preparations and in solving specific health and safety problems.

Consult the working environment organisation, both when selecting an advisor and in the actual process together with the advisor.

Select the correct advisor. Some advisors are qualified in specific areas, while others are qualified to be able to provide working environment advice within all areas.

For example, you can seek advice on:

- Purchasing of machines and tools
- Advice on replacing hazardous substances with less hazardous ones.
- Suppliers of technical equipment
- Measures to prevent accidents
- Assess work processes and establish action plans
- Measurement of noise, asbestos, PCB, etc.

In special instances, the Working Environment Authority may require an enterprise to use an authorised working environment advisor.

Companies and employees covered by the Construction Working Environment Bus (Bam-Bus) consultancy scheme are free to use this scheme for guidance on specific issues. Read more at www.bam-bus.dk

WORKING ENVIRONMENT ORGANISATIONS WITHIN ENTERPRISES

There must be health and safety cooperation at all enterprises. In this cooperation, the work environment tasks in the company are aimed at achieving a good working environment and thereby contributing to ensuring that the employees work under as good and safe conditions as possible.

All enterprises with ten or more employees must have a working environment organisation.

The same applies to construction sites and changing workplaces for companies that employ at least five people for at least 14 days.

The working environment organisation may have representatives of both employees and the management.

In enterprises with working environment organisations, a discussion must take place every year on how cooperation on the working environment is working and on working environment plans for the year to come.

Composition of the working environment organisation

The number of members and working environment teams in the working environment organisation are established in cooperation with employees and supervisors on the basis of the principle of subsidiarity. There must be at least the same number of working environment representatives and supervisors within the working environment organisation.

Supervisors in the working environment organisation must have the necessary knowledge of the enterprise and the part of the enterprise or construction site in question. All personnel must be able to contact with their working environment representatives to discuss working environment conditions within normal working hours.

All employees – including part-time employees – who are not business managers or supervisors are included in the number of people employed. This therefore applies to all staff who work full-time or part-time on construction sites or other changing/temporary workplaces outside the enterprise's main business site.

People who have been employed to work on a specific building site and who will only be working there are not normally included in the number of employees at the enterprise's main business site. If they move on to a new construction site, they will be counted from this point in time.

Annual working environment discussion

All businesses without a working environment organisation must have an annual discussion on how cooperation on the working environment is to take place and establish targets and working environment plans for the coming year's cooperation. It must also be assessed whether

1. THE WORKING ENVIRONMENT ACT AND SAFETY WORK

the previous year's goals have been achieved and whether the necessary expertise on the working environment exists within the company.

It is a good idea to document the discussion, especially when drawing up the enterprise's action plan.

Working environment work in enterprises with one to nine employees

Enterprises with one to nine employees are not obliged to create a working environment organisation. However, the employer must ensure that health and safety cooperation takes place by direct contact and dialogue between the employer, supervisors and other employees.

In enterprises without a working environment organisation, the employer must ensure that employees receive all necessary information on health and safety. Employees must also be involved in the planning and introduction of new technology and on the consequences for health and safety of the selection of equipment, personal protective equipment and technical equipment, etc.

However, on construction sites there is an obligation to create a working environment organisation if five or more people are employed by the same employer over a period of more than 14 days.

Working environment organisations in enterprises with ten to 34 employees

In enterprises with ten to 34 employees, it is necessary to establish a working environment organisation which consists of supervisors and elected working environment representatives, and with the employer or business manager taking the chair.

The working environment organisation must carry out both strategic general tasks and operational daily tasks.

Working environment organisations in enterprises with more than 35 employees

Enterprises with 35 or more employees must have a working environment organisation established with:

- one or more working environment teams and
- one or more working environment committees.

A working environment team consists of one supervisor and one working environment representative. A working environment committee consists of supervisors and working environment representatives from one or more working environment teams, with the employer or the business manager taking the chair.

Working environment committees within enterprises

The working environment committee consists of the members of the working environment team. If there are more than two working environment groups, the working environment representatives elect two members and the supervisors in the working environment groups elect two members to the working environment committee. The employer or a representative of the employer shall be responsible for the chairmanship. The members of the working environment committee and their deputies are elected for two years. Enterprises may agree on a term of office for working environment representatives of a maximum of four years. The working environment committee must plan, manage and coordinate health and safety work in the enterprise and conduct the annual working environment discussion.

The committee must also advise the employer on the resolution of working environment issues and on how the working environment can be integrated into the enterprise's strategic management and day to day operations. The committee must help to determine the size of the working environment organisation and advise the employer on the enterprise's competence development plan for working environment representatives and supervisors in the working environment organisation. The committee checks working environment work and must ensure that the working environment teams are notified about the working environment and given guidance on it.

The committee must participate in preparation of the enterprise's workplace assessment.

Once a year, the working environment committee must prepare a collective summary of accidents, poisoning incidents and health damage within the enterprise.

Furthermore, the committee must establish principles for training and instruction which are adapted to suit the working conditions at the enterprise and the needs of employees.

1. THE WORKING ENVIRONMENT ACT AND SAFETY WORK

A plan must be compiled concerning the structure of the working environment organisation, with information on members, and employees must be informed of the plan.

At the annual discussion, the working environment committee must, among other things, consider the committee's form of cooperation and meeting intervals.

On agreement, the employer and employees may opt to arrange the working environment organisation differently. However, this requires both an agreement at organisation level and at company level.

Tasks of the working environment team

The working environment team deals with day to day working environment tasks within the part of the enterprise or the building site covered by the working environment team.

The working environment team must undertake and participate in activities that protect the employees and prevent risks.



The working environment team must participate in the planning of health and safety work and in the preparation of the workplace assessment, including the inclusion of sick leave.

The team must check that the working conditions are safe in terms of the working environment and that effective training and instruction is provided in the languages spoken and understood by the employees. If necessary, use an interpreter.

The team shall also participate in investigations of accidents, poisoning and damage to health or near-accidents and report them to the employer or his representative.

It is also important that the working environment team continuously inspires other employees to conduct themselves in a way that promotes good working environment practice.

The working environment team forms the point of contact between the employees and the working environment committee and therefore must pass on working environment queries to the working environment committee, unless the working environment team is able to resolve the problems itself.

If the supervisor and health & safety representative are not present at the same time, the member present undertakes the health & safety group's tasks. Arrangements which are organised in the absence of the other must be reported to the absent party as soon as possible.

If there is no time to contact the chairman of the health & safety committee or the company's management, the health & safety team may, at its own initiative, stop the work or work process in the event of an imminent significant risk to the safety or health of the employees.

If work is stopped, the working environment team must immediately contact the management team for the enterprise and explain why it was necessary to stop the work.

Meetings of the working environment organisation within the enterprise

Besides the annual working environment discussion, the working environment team and the working environment committee will hold meetings as required so that it is possible to carry out the tasks assigned to the team and the committee.

The working environment committee will normally hold meetings if serious accidents, damage to health or near-accidents and damage take place.

Reception culture

Regardless of the size of the company, it is a good idea to draw up a plan for how to receive new employees, including apprentices, young people and foreigners who are not yet familiar with the rules, practices and procedures of the construction site.



It must be ensured that they learn a good safety culture and routines from the start so that they do not endanger themselves and others.

SAFETY MEETINGS ON BUILDING AND CONSTRUCTION SITES

The developer's responsibilities

At large building or construction sites, the developer's working environment coordinator must hold safety meetings. The purpose is to define and coordinate the individual companies' safety work in the shared areas.

Building or construction sites are regarded as large when more than one employer at the same time employs more than ten people on the building site. Everyone working on the building site is taken into account, including supervisors and building site managers.

The developer's working environment coordinator convenes the meetings and ensures that written minutes are kept on topics and decisions at the meeting. All employers (including subcontractors and sole traders) or their representatives take part in these meetings together with enterprises' working environment organisations at the workplace.

The coordinator must hold regular safety meetings at least once a fortnight. Extraordinary meetings are held as required or following serious accidents and near-accidents. It must be ensured that the decisions of the meetings are communicated to everyone at the site – also to those for whom Danish is not their first language.

WORKING ENVIRONMENT WORK ON BUILDING AND CONSTRUCTION SITES

The enterprise must establish a working environment organisation on construction sites and other temporary and changing workplaces outside the enterprise's fixed workplace if five people or more are employed for the same employer for a period of at least 14 days. Also remember to include in the figures the number of any contract workers.

This is applicable irrespective of how many people are employed within the enterprise, and irrespective of the fact that the employees on the building site are at the same time covered by a working environment organisation within the home enterprise.

The working environment organisation on the building site consists of an employee (working environment representative) elected by and from employees on site, the supervisor on site and the employer or his representative.

The employer, health and safety representatives and supervisors in the health and safety organisation must participate in start-up meetings, safety meetings and safety rounds convened by the developer or health and safety coordinator.

Working environment committees on building and construction sites

If there are 35 or more employees from the same enterprise working on a building and construction site for at least four weeks, the enterprise must set up a working environment committee.

The working environment committee is made up of members or representatives from the working environment teams created on site.

The committee must actively assist with coordination of working environment work with other enterprises when they are all working on the same site.

Working in other enterprises' areas

Anyone working in an area operated by a different enterprise must work in compliance with the working environment regulations applicable to the enterprise in whose area they are working, as well as the regulations applicable to the work they have to do.

ELECTION OF WORKING ENVIRONMENT REPRESENTATIVES

In companies with 10 employees or more and at construction sites with five or more employees for the same employer for a period of at least 14 days, the employees must elect a working environment representative who represents them in the working environment organisation and at the developer's safety meetings.

1. THE WORKING ENVIRONMENT ACT AND SAFETY WORK

It is important that employees play an active part in the working environment organisation to ensure that the working environment work proceeds satisfactorily. Therefore, the management team within the enterprise must make the effort to persuade employees to elect a working environment representative.

If they are unsuccessful, the supervisor will work alone on the working environment team until the employees have elected a working environment representative. The employer must regularly encourage employees to elect a working environment representative.

The working environment representative should be elected by all employees covered by the working environment team or the working environment organisation. The employer, business managers and supervisors do not take part in this election process.

The regulations on election of shop stewards within the collective agreement area in question normally define who can be elected.

Staff normally elect a working environment representative for two years at a time, but if the enterprise and the employees agree, the period of office can be extended to up to four years.

The working environment representative is protected from dismissal or deterioration of employment terms in the same way as shop stewards within the collective agreement area.

In the event of disagreement concerning protection, it must be considered by professional law - i.e. at mediation meetings between the parties and possibly in the Labour Court.

SUPERVISORS

Appointment of supervisor for the Working Environment Organisation (WEO)

Together with the health & safety representative, the supervisors constitute the members of the health & safety team.

The supervisor who has direct management and supervision of the work within the EHS group's area must be included in the EHS group.

Supervisors for the health and safety organisation are appointed by the employer from among the company's supervisors. The choice of supervisor must be based on an assessment of who has both direct management and a good overview of the entire area.

The supervisor who is a member of the working environment group acts as representative of all managers in the group's area.

Supervisors in the working environment groups have both the right and the obligation to participate in the statutory working environment training, and they must also be given the necessary time to take care of the working environment work.

The supervisor representatives in the working environment committee are elected from among the supervisors who are safety group members.

A supervisor must not be placed at a disadvantage because of his/her work as a member of the working environment organisation. The supervisor cannot be dismissed without further notice due to his or her working environment work. If the supervisor or his/her organisation or the employer states that the dismissal is based on working environment conditions, the supervisor's employment may not be terminated until the dismissal has been negotiated by the relevant parties.

Supervisors cannot be elected and may not participate in the election of working environment representatives.

WORKING ENVIRONMENT TRAINING

Working environment representatives and supervisors within the working environment organisation must undertake mandatory working environment training for three days at the premises of a provider approved by the Working Environment Authority. Working environment training must be completed within three months of the working environment representative or supervisor in question being elected or appointed.

Supplementary working environment training

The employer must offer working environment representatives and supervisors within the working environment organisation the opportunity to participate in two days' supplementary working environment



1. THE WORKING ENVIRONMENT ACT AND SAFETY WORK

training in their first year of office. The offer applies to those who have completed the three-day mandatory health and safety training course. The offer must be recorded.

The supplementary two-day training courses must be offered and begun within the first nine months and completed within the first 12 months of the employee's period of office.

Health & safety representatives and supervisors in the health & safety organisation must be offered supplementary training of at least 1.5 days in each year of office, for as long as they are part of the organisation. Training courses totalling 1½ days must be offered and be capable of commencement within the same year in office.

Supplementary working environment training must ensure relevant updating and underpin the expertise of working environment representatives and supervisors within the working environment organisation.

In companies with a working environment organisation, a competency development plan must be drawn up for the supplementary training to be offered to working environment representatives and supervisors in the working environment organisation. This skills development plan must take into account the needs of the enterprise's working environment.

BFA - Building & Construction will, in cooperation with various course providers, continuously develop and offer courses relevant to the industry in connection with the supplementary working environment training.

A summary of courses and providers can be found at www.bar-ba.dk.

Rules on special health and safety training

In connection with a number of work involving asbestos, scaffolding-erection, welding, telescopic loaders, cranes, etc., special health and safety training is required.

The employer may not employ anyone with work covered by the special training requirements that does not have either a certificate or a training certificate from AMU or a technical school.

If you have acquired your health and safety training or certificate in a country other than Denmark and are to work within the relevant work area in Denmark, the Working Environment Authority must assess the qualifications of the individual persons before they commence work in Denmark. In a number of jobs, the employer may not employ persons who do not have a letter of recognition from the Working Environment Authority.

Read more about the rules concerning occupational health and safety training and the rules for recognition of qualifications acquired abroad at www.at.dk.

As a holder of a foreign education certificate, you or your employer must apply to the Working Environment Authority for recognition of your qualifications.

The application shall contain:

- Proof of nationality, e.g. copy of passport
- Name, address and date of birth
- Information on whether it is temporary, occasional or permanent work
- Name and address of the submitter
- Proof of vocational experience and/or training.

The application must be sent to:

Working Environment Authority

Landskronagade 33

2100 Copenhagen Ø

or the electronic mailbox: postkasseanerkendelse@at.dk

Attendance on a number of health and safety training courses may not commence until the Danish Working Environment Authority has assessed the qualifications of the persons and issued recognition letters.

Further information can be obtained from the Danish Working Environment Authority or via guidelines (F.1.7) at www.at.dk.

WORKPLACE ASSESSMENT



All enterprises with employees must create a written workplace assessment (WPA). The WPA ensures that the working environment work is systematic, and helps prevent accidents and injuries.

The enterprise must ensure that the WPA includes the following five elements or phases in its WPA work:

- Identification and documentation of the enterprise's overall working environment.
- Description and assessment of the enterprise's working environment problems.
- Consideration of the enterprise's sick leave.
- Prioritisation of solutions for the enterprise's working environment problems and preparation of an action plan.
- Guidelines for action plan follow-up.

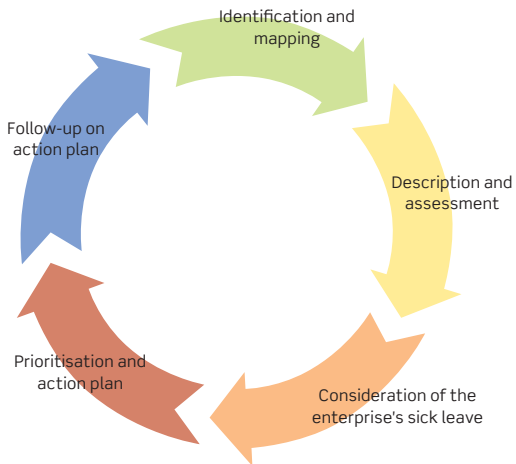

Enterprises can themselves select the method they want to use to create a WPA, although the contents are specified in the Working Environment Act. At minimum, a WPA must address:

- Physical effects (e.g. noise, cold and draughts).
- Chemical effects (e.g. sealant)
- Biological effects (e.g. risk of infection)
- Ergonomic effects (e.g. working positions and heavy lifting)
- Psychological effects (e.g. time pressure)
- The risk of accidents (e.g. working at height).

Construction companies mostly work outside the main work address. When working with the workplace assessment, it is therefore important to assess whether there are special working environment problems at the changing or temporary workplaces that must be included in the assessment. In such instances, the WPA may be based on the general work functions. If there are special conditions at one or more of the workplaces that affect how the work is carried out, this must be stated in the WPA.

The APV may be based on the enterprise's typical tasks. There may be special conditions in place at individual building sites. These special conditions may, for example, be specified in the tender documentation or the developer's plan. The enterprise must alter the WPA if there are special conditions on the building site. It is important for you to agree guidelines on how the WPA will be adjusted to suit the special conditions.

The part of the enterprise's WPA which deals with work on the specific building site must be available to employees on the building site.

For example, if someone in the company works with or may be exposed to hazardous substances and materials, a chemical risk assessment must be carried out.

If there are minors under 18 employed within the enterprise, the risks which young people may face must be described separately within the enterprise's WPA.

The WPA must be in writing and accessible at the enterprise to employees, business managers and the Working Environment Authority.

1. THE WORKING ENVIRONMENT ACT AND SAFETY WORK

When there are changes in the work that have an impact on the working environment, the workplace assessment must be revised. For example, if new work processes are introduced, machines are purchased or an accident occurs. The WPA must be revised at least every three years. The management team and employees must work together on the entire APV process.

The employer holds overall responsibility for involving the working environment organisation and employees in planning, implementation and follow-up of the WPA.



Find out more about WPAs within building and construction enterprises at www.bfa-ba.dk or from authorised working environment advisors and the Working Environment Authority. On the Working Environment Authority's website, you can download a digital industry-specific tool, for example.

MINORS UNDER 18 YEARS OR AGE

There is a long list of special regulations and provisions which apply if minors under 18 are employed within an enterprise. The rules cover working hours, types of work tasks, use of technical aids, etc. As can be seen later in the chapter, many of the special rules do not apply to young people and students in vocational education and training.

Some of the most important regulations in respect of the working environment for minors are described here. These are also described in connection with the individual items of machinery and tools in this manual.

Minors under 18 are generally not permitted to work with:

- Hazardous substances and materials (hazard labelled) or in spaces in which these products are in use and the person may be affected.
- Lifting of loads in excess of 12 kg.
- Pulling and pushing which may damage the health of the person.
- Monotonous work that places a strain on the body over longer periods.
- Hazardous machinery and technical aids, e.g. cutting tools, chain-saws, transporters, cranes and other lifting gear, welding equipment, vibrating hand tools, excavation and loading machinery.

- Work which involves a risk of falling or collapse.

WPA

If there are young people under the age of 18 employed in a company, the risks that the young people may face in the company must be described separately in the company's workplace assessment (WPA). However, the WPA requirement does not include family enterprises or work in the employer's private household.

Training and instruction

The employer must ensure that minors receive thorough training and instruction so that they can carry out their work in a fully responsible manner. While working, minors must be under the effective supervision of a person aged over 18 and who has the necessary insight into the work.

Contact with parents

Employers who employ young people who are under 15 years of age or who in compulsorily educated must inform the young person's parents or guardian of the employment. This includes information about working hours, possible accident and illness risks, etc.

Minors and students on courses of vocational training

Many of the general restrictions cited which are applicable to minors are not applicable to minors over the age of 15 if the work is part of a vocational training course aimed at giving them skills. Usually this refers to traditional apprenticeship courses, as well as students doing practical training as part of a basic vocational course (EGU students), or if minors have completed their vocational training before they reach the age of 18.

Irrespective of whether or not minors under 18 are undergoing training, there are still restrictions preventing their employment for:

- Work processes which involve a risk of explosion.
- Work which involves handling pressurised cylinders.
- Work under high air pressure, e.g. in pressure chambers or diving work.
- Work which may involve a risk of suffocation in an oxygen-starved atmosphere.

1. THE WORKING ENVIRONMENT ACT AND SAFETY WORK

- Work in which minors would be subject to physical loads which in the short or long-term would be harmful to their health or development; unnecessary physical strain and inappropriate working positions or movements must also be avoided. This includes:
 - minors must not do work where the tempo is determined by a machine.
 - Lifting of heavy weights must normally not exceed 12 kg.
 - The total load during manual pulling or pushing must not constitute a risk to health and safety.

Work which involves requirements for constant manual handling which involves force or causes physical strain must be restricted to short periods.

INDUSTRIAL INJURIES

Industrial injuries is a common term for occupational accidents and illnesses.

Occupational accidents

An occupational accident is a sudden incident in connection with work that leads to a person being physically or mentally injured.

According to the Act on Industrial Injury Insurance, an occupational accident can also be an injury that occurs after an impact that has lasted for a maximum of five days. For example, an employee, supervisor or contractor could fall from a roof where he is working: this constitutes an industrial accident. If this person is at work when the accident happens, it does not matter what the work involves and where it happens.

If a traffic accident happens to an employee while this person is at work, this also constitutes an industrial accident.

Occupational illnesses

A work-related disease or injury is an occupational disease or injury occurring over a prolonged period as a result of work or the conditions under which work is carried out.

This may, for example, include lung cancer where it has been ascertained that the cancer was caused by exposure to asbestos fibres.

In some instances, it may be difficult to define clearly what constitutes an accident and what constitutes a work-related illness or injury. Hearing damage following an explosion is an accident, for example, while hearing damage following long-term exposure to loud noise is a work-related injury.

A back injury following a fall is an accident, while a back injury following prolonged work in an incorrect working position is a work-related injury.

Reporting accidents

Industrial accidents, including poisoning incidents and sudden lifting injuries, must be reported to the Working Environment Authority by the employer within nine days of the day of injury.

The reporting obligation applies to all occupational accidents where there is at least one day's absence from normal work beyond the day of injury.

The injured person must have a copy of the report and the health and safety representative must have access to the report.

When the day(s) of absence occur is not crucial. What is crucial is whether the absence is caused by the industrial accident.

Any person is entitled to report an accident at work. This includes the person who has been injured, or their organisation.

The Working Environment Authority must receive these reports so that it has the opportunity to investigate the accident and prevent similar accidents in future.

The National Board of Industrial Injuries and the employer's insurance company must receive the reports so that the employee can receive compensation, where applicable.

1. THE WORKING ENVIRONMENT ACT AND SAFETY WORK

The report must be submitted digitally using the Labour Market Insurance and the Working Environment Authority's electronic reporting system for occupational accidents - EASY. Find out more about the EASY system on the Working Environment Authority website: www.virk.dk.

The EASY system can also be used by individual enterprises to register near-accidents and accidents not leading to absence from work in connection with the enterprise's preventive working environment policy. These reports can be viewed only by the enterprise itself and require access using a digital signature.

Reporting work-related injury and illness

Doctors and dentists must report to the Working Environment Authority and the Labour Market Insurance if they discover or suspect that a person has suffered a work-related illness or other harmful effects at work.

Other persons may also report suspected work-related injuries or diseases.

Industrial injury insurance and industrial injury compensation

The employer is obliged to take out a statutory insurance policy that covers the consequences of occupational accidents among employees and register for the Labour Market's Industrial Insurance in relation to occupational diseases. The insurance covers certain expenses for treatment, compensation for loss of occupational capacity, permanent disability and compensation to dependants. The insurance does not cover the employer if he/she suffers an occupational injury, unless the employer has taken out voluntary insurance.

This insurance provides cover irrespective of who is responsible for the accident or injury.

It does not cover loss of earnings or pain and suffering. As a rule, these are covered by the employer's industrial liability insurance, which should be taken out even though it is not required by law.

Accident analysis/learning from accidents

The enterprise must systematically investigate accidents and occupational illnesses in order to prevent similar injuries in future.

In companies with a working environment organisation, the employer must ensure that the working environment organisation follows up on serious accidents, serious poisoning or other health injuries or near-accidents, and when there are other special circumstances that require follow-up.

Once a year, the working environment committee must prepare a collective summary of accidents, poisoning incidents and health damage within the enterprise.

The employer must inform the client's working environment coordinator if an accident has taken place at the construction site. The events and analysis will be discussed at the safety meeting, possibly an extraordinary one.

The purpose of this investigation of accidents is not to identify liability or blame. Instead, this method must clarify what options there are for preventing similar injuries in future.

It is often necessary to correct the workplace assessment (APV) in the light of the new knowledge gained during this analysis.

Start preventive work as quickly as possible following an accident. This is an important signal that prevention is a high priority.

Procedure

This method is divided into three stages:

1. Determining the facts
2. Analysing the accident
3. Devising preventive solutions.

Determining the facts

Collect as much information as possible on what happened, and the circumstances under which the chain of events took place.

1. THE WORKING ENVIRONMENT ACT AND SAFETY WORK

Also remember to look at underlying causes, such as time pressure or a lack of instructions.

Start documentation as quickly as possible while the incident is still fresh in people's minds and any witnesses are still on site.

Carry out a thorough collection of facts, opinions, experiences and observations relating to the accident in question. Take photos where applicable, or draw a sketch.

Talk to all relevant people. For example, it may be the construction management who can shed light on the underlying cause of the accident.

Think broadly when documenting. Back strain after a sudden lifting injury can, for example, be due to cooling of the body due to rain or cold.

Analysing the accident

When all important information about the accident has been described, you can start analysing it.

Do this step by step to answer both what happened and why it happened.

Remember that in the case of most accidents, there may be several causes. It is important to identify all these as this gives you the best chances of devising preventive measures within the enterprise. Only use the information gathered in the mapping.

The best result will often be achieved if the working environment organisation collectively carries out the analysis and allocates the necessary time for the analysis.

Devising preventive solutions

Review the individual stages of the analysis in order to identify what could have prevented the accident.

Then evaluate all proposed changes to workflows and other preventative measures and decide which are to be implemented immediately and which are to be implemented at a later date.

Finally, decide who is responsible for implementing the preventive measures, when they should be ready and how the results of the survey can be used in your workplace assessment.

The method outlined is described on the Working Environment Authority website at www.at.dk.

First aid

The company must ensure that the necessary measures are taken regarding fire, rescue and first aid. Among other things, the company must ensure:

- that the workplace is equipped with appropriate fire equipment and rescue equipment, as well as the necessary aids for first aid in the event of an accident
- that there are specially trained persons who can provide first aid in connection with any accidents.

Please include these issues – both in connection with the preparation of an emergency response plan and in connection with the preparation of the WPA and, if necessary, prepare a list of the persons who can provide first aid.

1. THE WORKING ENVIRONMENT ACT AND SAFETY WORK

SITE PLAN

The construction site must be planned and arranged so that work can be carried out safely with regard to health and safety. This means that safety on and around the construction work must be taken into account right from the planning phase.



You should, for example, plan how to:

- ensure that the driving and pedestrian routes are built to cope with the traffic on them at all times and function all year round - no matter when they are built
- establish safe and secure access routes to buildings, excavations and scaffolding, etc.
- ensure that all necessary technical equipment can be used
- set up temporary railings where there is a risk of falling and falling through. This also applies to excavations, holes and shafts – all places with different levels that entail a risk of falling
- secure scaffolding
- ensure order and tidiness on the construction site
- establish legal and safe electrical installations
- establish legal and adequate lighting, not least in common areas for several contractors and on access routes;
- ensure hazard-free installation of building elements, e.g. concrete elements, roof cassettes and trapezoidal panels
- establish fixed workplaces for bending reinforcement bars, cutting timber, etc.
- establish good access and storage conditions, e.g. with a firm surface on material storage areas, so that technical equipment can be used
- erect cranes, etc. as appropriate
- delimit particularly hazardous work

Access to the site

Hang up an overview plan at the entrances to the construction site to help new arrivals find their way. The plan must show where personal protective equipment, speed limits, uniform driving, etc. are mandatory, which have an impact on safety.

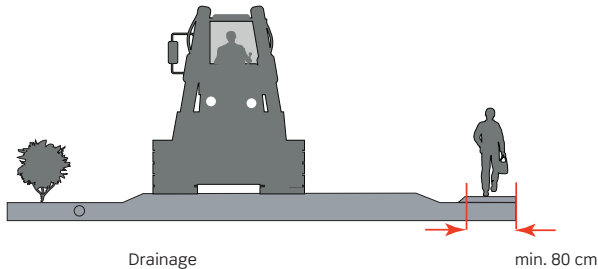

Entries and exits should be separated and clearly marked with signs to separate pedestrian traffic from the vehicle.

Traffic Roads and pedestrian walkways must be planned and constructed so they able to handle the traffic using them at all times.

The following should be taken into account:

- weather conditions – with the necessary drainage and stable construction of roadways and with a surface that allows maintenance and snow clearance
- the use of the necessary technical aids for the transport of materials
- to keep roadways as straight as possible so that long and heavy vehicles do not have to reverse. If necessary, make a turning position.

Fencing

Fence off and lock the building site and site huts out of working hours. All buildings should be locked.

Order and tidiness

A messy building site creates a greater risk of accidents. At the same time, progress can be compromised and cause conflicts between companies on site. It is the responsibility of the developer to coordinate and define this in shared areas and it must be specified in the Health and Safety Plan (HSP), and where necessary discussed at the safety meetings.

The HSP must state how to keep the construction site tidy, when, and who is responsible. On construction sites where a HSP is not required, this must be agreed between the individual contractors.

Good advice on keeping the building site tidy:

- Do not stack materials so that they can tip over or otherwise become hazardous. Only place materials in the locations designated for them.
- Ensure appropriate placement of waste containers – both indoors and outdoors.
- Storage sites must have good foundations and raised above the rest of the ground.
- Place waste and empty packaging in specially designed areas or in containers and make sure that they are emptied regularly.
- Always follow the municipality's waste regulations when disposing of waste.

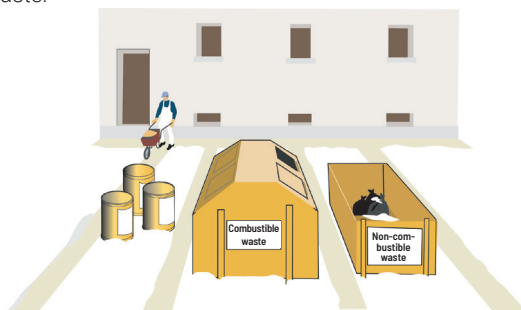

2. SITE PLAN

- Do not place waste and materials to prevent you from clearing the area of snow, ploughs and water.
- Electrical cables must be suspended or buried.
- Pipes for electricity, compressed air, gas and water for construction site installations can be suspended from walls or ceilings. If you have to place them on the ground or floor, they must be positioned so that nobody can fall over them or damage them.
- Dry sweeping is not permitted. Vacuum instead and clean in a way that avoids dust and other harmful contamination. Use vacuum cleaner - Dust class H.
- Keep holes for wells and similar well covered.
- Do not remove covers, railings and other safety measures when cleaning up.
- Arrange the space so that materials and similar are not in the way of vehicle and pedestrian traffic.
- Establish specially marked areas with the option of storage for each contractor.

Screening for falling objects

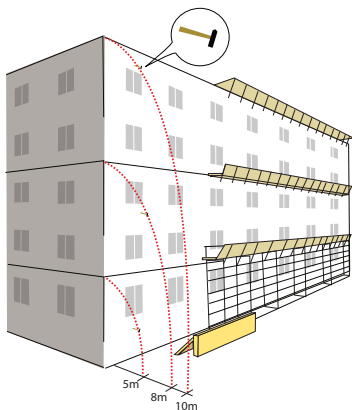

Protect both vehicle and pedestrians on site from falling objects – both inside and outside. Erect screens, safety nets or other covers on scaffolding and buildings where people are moving through entries and alongside buildings.

If it is not possible to screen or block off safely, traffic will have to be relocated.

Screens must protrude at least 2 m and may consist of 25 mm thick boards. Instead of screens, a safety net can be used if it consists of a fine mesh net with a mesh size not exceeding 2 cm (not to be confused with a dust net). A denser mesh size may be necessary if, for example, threaded rods, bolts, nuts, etc. may be dropped.

When placing materials and tools on roofs or other high places, make sure that they cannot slip or be torn by the wind.

When you place materials and tools on roofs or in other high places, you must ensure that they cannot slip or be blown off by the wind.

ACCESS ROUTES

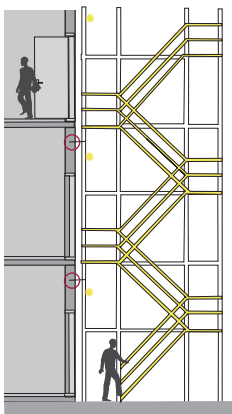

Safe access routes must always be established to buildings, excavations, scaffolding and storage sites, etc. Access routes must be established without potholes, uneven surfaces, and kept free of waste and materials.



Stairs

Permanent stairways should be set up in buildings as early as possible so that they can be used as access routes on site. Remember that they must have guard rails on both stairs and half-landings before people start to use them.

Full guard rails with hand, knee and foot rails must be fitted on landings. It will normally be possible to dispense with the foot rail on stairways.

If it is not possible to use the existing stairs, a scaffolding stairwell tower should be erected. This applies to both buildings and excavations.

Ladders

Ladders may only be used as access routes at low heights and only if there is not too much traffic on them. Only light materials and tools that can be carried in one hand may be transported. Ladders can also be used as escape routes.

Ladders must be secured at the top and have an appropriate pitch so that they remain stable. There must be a handle or hand fastener approx. 1 m above the top level.

Roads

Roadways on the construction site should be wide and in such good condition that both people on foot and vehicles can travel safely.

- Lay, or example asphalt surfaces instead of boards
- Separate vehicle and pedestrian traffic
- Keep roads one way
- To the extent possible, avoid heavy and long vehicles having to reverse. If this is unavoidable, prepare procedures on how reversing can take place safely. This could, for example, be that reversing is controlled by a "flagman"
- Organise roads so that the use of technical equipment is not obstructed
- Regularly remove mud from road surfaces and ditches.

It must be easy to clear snow and gravel. If night frost is likely, gravel or salt (Urea) should be used. Frost-free grit bins and low-lying, drained snow dumps should be ready for use before winter.

In dry periods, it may be necessary to water roads to prevent the spread of dust.

Structures and surfaces

It is recommended to use the existing roads and parking areas as construction site roads.

The temporary roads on the construction site must be constructed so that heavy traffic can reach the site whatever the weather. Surface water must therefore be drained off so that they do not become waterlogged.

The roads may, for example, be raised above ground level and provided with ditches which effectively lead the water to a permanent drain.

Walkways

Walkways must be raised above ground level or be otherwise built up so that they can be used at all times and are free of water and mud.

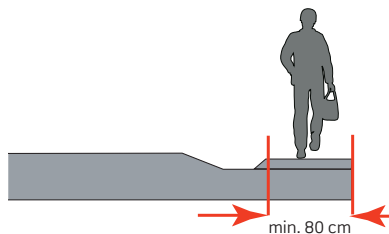

Walkways should be arranged so that it is possible to use flat trolleys, sack trolleys, wheelbarrows and other suitable means of transporting materials, etc. If, in exceptional cases, transport of materials is to take place on the roads, ensure that vehicles and pedestrian traffic are kept separate. Thus may be done by physically directing the traffic so that there is no mixing with heavy traffic, such as lorries, excavators, telescopic loaders or similar.

When transporting materials, the minimum walkway width must be 80 cm, but it may be necessary to make them wider.

2. SITE PLAN

The width can be restricted to 60 cm in the case of access routes to be used by people only.

It must be possible to walk between the parking area and the site hut in ordinary footwear. It must be possible to walk between the site huts and your place of work wearing work footwear. Wellington boots should be worn during excavation work.

Level differences on the ground should be corrected by using stairs or ramps.

Escape routes

There must be escape routes on the construction site so that all employees are able to get to a place of safety in the event of a hazardous situation.

The number and location of escape routes depends on the type of work on the construction site, although there should be at least two escape routes. This should be evaluated for each job of work.

Elevators must not be used as escape routes.

Escape routes are mandatory in the following situations:

- Work in excavations or pits - including deep excavations where ladders cannot practicably be used as escape routes
- Roof work
- Roofing felt work where there is a risk of fire. It may be necessary to have more than two escape routes in these instances
- Piping, sewage, water, district heating, gas, etc.
- Work with demolition of building parts
- Erection and work on scaffolding
- Work in confined spaces, wells, etc.
- Work in lifts, trucks, cranes, masts, chimneys, etc. It must be possible to call for help from the location, e.g. for emergency lowering.
- Work in ducts, pipes, etc.
- Work in crawl spaces, roof spaces, etc.
- Staying in huts, crew trolleys, containers, etc.

- Work areas that are liable to flooding
- Areas where employees may be exposed to hazardous substances and materials

On construction sites where more than 10 people from two or more employers are working at the same time, the escape routes must be described in the Health and Safety Plan (HSP). It must also be described who is to establish, maintain and remove the escape routes.

In smaller places, agreements must be made directly between the client and the contractor.

Normally there must be escape routes in at least two directions. If this is not possible, there must be visual monitoring, contact with one or more persons or other special measures that ensure the workplace.

Escape routes and emergency exits must be provided with sufficient emergency lighting in the event of a power failure.

Before employees start on site, it is the responsibility of the individual employer to assess the need for escape and evacuation routes in connection with their own work. If this assessment requires changes, the HSP must be revised (on construction sites requiring PSS).

Pay particular attention to escape routes and contingency plans in connection with work in very high buildings or very deep excavations where rescue services are not immediately able to rescue from outside or with ordinary rescue equipment.

Site huts

Set up site huts so that parking and storage of materials between the huts is prevented as far as possible.

Conduits for electricity and telephones and pipes for water and drains must be positioned appropriately so that individual huts can easily be connected to one another.

2. SITE PLAN

The site hut area access routes must be well lit so that you can orientate yourself safely - at least 25 lux. Water and drainage pipes must be frostproofed.

Consider the following when positioning the site hut area:

- There must be an access route to a public road or parking lot
- The site hut area is located in the immediate vicinity of the workplaces
- It must be possible to access the site hut area from a public road or parking lot without passing through an area where you should wear a helmet
- It must be possible to access the huts from the public road in ordinary footwear regardless of the weather
- Position the huts so that there is at least 2.5 m between window sides. This ensures there is sufficient daylight.
- There must be escape routes in at least two directions from all huts. These routes must be at least 2 m wide and must not be blocked by materials or other items
- Place the site huts where they are protected against falling materials and are as inconvenienced as possible by dust and other air pollution, noise, vibrations, odours, etc.

Pay attention to coverage with mobile phones in outer areas and during underground work.

SITE HUT FACILITIES



When the work on the construction site starts, welfare facilities must always be assigned. The employer is responsible for ensuring that the necessary facilities are available.

Normally, this will be in the form of a mobile workmen's hut, which includes:

- Toilet
- Washbasin with hot and cold running water
- Bathing and changing facilities

- Separate changing room and dining room
- Two lockers for each employee
- Refrigerator
- Drying cabinet
- Possibility to heat food and water

The requirements for welfare facilities can also be complied with by employees using welfare facilities in an existing building – i.e. toilets, canteen, bathroom, changing rooms, etc.

However, the facilities must have at least the same utility value as standard mobile workmen's huts.

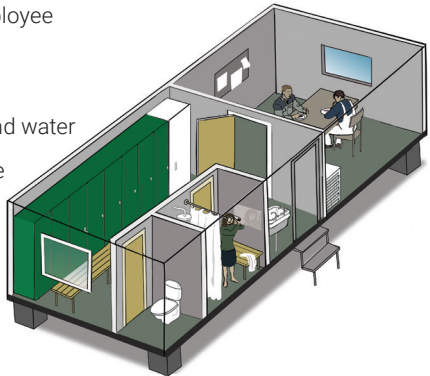

Connection to drains

If work on site lasts for more than two months, toilets must always be connected to the sewer.

If the duration of the work is less than two months, the toilet must be connected to a sewer, if this can be done without trenching, etc.

Drainage-free toilets must be of the same hygienic standards as toilets with water flushing and drains.

Quantities and distances

Welfare facilities must be situated conveniently in relation to one another and the individual work sites. There must be:

- One wash basin for every five people
- One shower for every ten people
- One toilet for every fifteen people.

There must be a distance of no more than 200 m or a transport time of five minutes to a toilet.

Short-term work

Special rules apply to welfare measures if tasks:

- lasts a maximum of three days
- does not exceed six man-days
- employees start and end their daily working hours at a location other than the construction site.

In the case of short-term work, the employer must ensure that during work, employees have access to:

- a toilet
- a suitable eating area if there are lunch breaks during work
- a wash basin with hot and cold running water
- changing rooms and the possibility of storing clothes and personal belongings
- it must be possible to dry workwear if it gets wet during work.

In addition, there must be showers and changing rooms where ordinary clothing and workwear are separated if:

- the work is very dusty or messy
- the work entails a risk of infection from materials
- the work is very dirty
- the work entails a risk of coming into contact with substances and materials that are harmful to the skin or which it is important to prevent the spread of
- the work exposes the employee to high temperatures or is physically very strenuous.

Special requirements – sewage work, asbestos, asphalt, lead, epoxy, polyurethane, etc.

If work is carried out where the employees can come into contact with substances and materials, bacteria, etc., which can be harmful to health, there are special rules for the design and use of, among other things, bathing and changing facilities. See, for example, the section on asbestos, epoxy and waste water.

Layout of huts

The internal walls and floors of huts must be easy to clean. The height in the room must be at least 2.1 m. In very large units (pavilions), however, the height must be at least 2.3 m.

The rooms must be well ventilated, illuminated and insulated and the temperature must be at least 18°C when used. Tools, materials and similar items must not be stored in these rooms.

Canteens

The canteen must be at least 1 m² per person + in addition 1 m² to the total area. There must be a refrigerator and the possibility of heating food and water for coffee, etc. The room must have two ventilation openings.

The windows must constitute at least 10% of the floor area. They must have blinds and at least one window must be able to be opened.

In mobile offices produced on or after 1 July 2021, new and supplementary rules shall apply :

- The canteen must be at least 0,9 m² per person + in addition to 1 m² for the total area.
- There must be a refrigerator and the possibility of heating food and water for coffee, etc.
- The room must have two vent valves, mechanical fans, etc.
- The windows must constitute at least 10% of the floor area. They must have sun shades and at least one window must be able to be opened and function as a rescue opening.

Changing

The changing room must be at least 1 m² per person, in addition to washing and showering facilities.

The room must be fitted with a ventilation opening.

Employees must be able to store their everyday clothes and workwear separately.

This may either be two lockers or one divided locker. Each individual locker must measure 25 cm x 50 cm x 170 cm. A divided locker must be twice as wide, i.e. 50 cm.

There must be padlocks on the lockers, and they must have a shelf and a vent to the outside. There must be a bench by the lockers.

It must be possible to dry workwear in the lockers or on a common hanger.

In mobile offices manufactured on or after 1 July 2021, new and supplementary rules shall apply:

- The room must be fitted with two vent valves of at least 100 cm², mechanical fan or similar.
- It must be possible to dry workwear in a drying cabinet in the site hut.

Showers

It must be possible for staff to go directly from the changing room to the shower. Showers must be supplied with hot and cold running water.

The floor area of each shower must be at least 1 m², but only 0.64 m² for shower cabinets.

The remaining area up to 1 m² is added to the changing room.

Ventilation facilities must be provided, mechanical where possible.

In mobile huts produced on or after 1 July 2021, there must be internal access from changing rooms to the shower, which must meet the following requirements:

- The shower must be supplied with running cold and hot water.

- The shower must have a front compartment with lockable door, seating and the possibility for hanging or unloading clean and dirty clothing in an appropriate manner. It must be possible to keep the front compartment dry during use of the bath. The floor area in the shower and front room must together be a minimum of 1.8 m².
- There must be adequate ventilation for showers and showers with mechanical ventilation.

Toilets and washbasins

Toilets on the building site must normally be connected to the drains and have water flushing.

If it is not possible to connect the toilet to the drains, the toilet bowl and waste tank must always be separate, and overall the toilet must be of the same hygiene standard as a toilet with water flushing.

The toilet cubicle must be at least 1 m².

If there is access to the toilet from outside, the room must be fitted with a washbasin. The floor area must be at least 1.2 m².

In mobile workmen's huts manufactured on or after 1 July 2021, the construction site toilets must:

- have a floor area of at least 0,95 m² and be fitted with a vent valve of at least 100 cm², mechanical fan or similar.
- be able to dispose of sanitary waste.
- be provided with a flushing handle and have a connection to the sewer system or, where necessary or appropriate, be fitted with a grinder of sufficient capacity connected to a collection tank.

There should also be a basket or similar for storing new toilet paper.

There must be internal access from changing rooms to washbasins, which must meet the following requirements:

- There must be running cold and hot water

2. SITE PLAN

- The floor area around each sink or mixer must be at least 1 m².
- The necessary cleaning agents must be available.

Lightweight mobile huts

The site hut can be a mobile light truck if it meets the same requirements as for the layout of standard site huts. See previous section on this.

If the employer has a maximum of four employees working on the site and the maximum number of weeks is two, then the mobile light truck may be smaller than a standard mobile workmen's hut.

Construction work

In the case of road and other construction work where the construction site moves during the work, it will in special cases be possible to ease the regulations, as the facilities will be established continuously in the immediate vicinity of the construction work. This applies to the following conditions:

- Toilets are not required to be connected to the sewer
- The same room can be used for changing and eating. However, this does not apply if the facilities are established jointly for the employees of several employers or if showering is available.
- Showering is only required if water and sewer connection is possible. However, the shower must be established if the work:
 - is very dusty or otherwise very dirty
 - entails a risk of contamination with materials that are infectious
 - entails danger of coming into contact with substances and materials which it is important to remove from the skin for health and safety reasons
 - expose the employee to high temperatures or to heavy physical exertion.

When multiple genders share site huts

When there are different genders on the construction site, it applies to the site hut trolley that there must either be separate bathrooms and changing rooms or that it must be possible to use the same room separately.

If it is not possible to have separate bathrooms and changing rooms, it must be agreed in writing, for example, how the different genders can use the same bathrooms and changing rooms.

There must be a lockable bathroom and changing room in site huts produced on or after 1 July 2021, so that all genders can use the site hut at the same time.

For "Environmental vehicles", the same rules apply as for site huts produced before 1 July 2021, even if they were produced on or after 1 July 2021.

Overnight accommodation, major projects

For larger construction, civil engineering and infrastructure projects, accommodation facilities for employees may need to be established. This is normally not part of the Working Environment Act. There are thus no clear rules for the design and operation of accommodation facilities. Some collective agreements contain special rules about this. The following are therefore recommendations from BFA Building & Construction and relate to cases where this is not covered by the regulations of the collective agreements.

It is by no means always possible to position accommodation facilities immediately next to building and construction projects. When locating accommodation facilities, focus should always be placed on having optimal conditions regarding transport, where it is of particular importance that there is easy access to public transport and procurement opportunities for daily necessities with opening hours that suit the working hours of the workplace. Close proximity to leisure and sports facilities is also a must.

2. SITE PLAN

When running the camp, it is important to consider the following:

- Permanent caretaker/camp manager who can also support camp residents' social life
- High cleaning standard. Good washing facilities/options
- Simple and "home" leisure offers. Smoking and alcohol policy
- Dietary options: Breakfast and dinner; flexible arrangements so that people can get something to eat at "odd times".

The layout should support the following:

- Good sleep hygiene, first and foremost by preventing noise.
- Hygienic storage and preparation of food, where a certain degree of privacy regarding cooking and eating is taken into account
- Adequate and healthy food in the morning and evening camp
- Communication with the supporting country, e.g. telephone and internet connection
- Social community.

Caravans and containers are not ideal accommodation facilities for construction workers.

STATIONARY WORK SITES

Work with stationary circular saws, bending tables, threading machines and other work that is carried out at the same site for a long period of time must take place in buildings, sheds or tents and as a minimum under wind deflectors with canopy roofs etc.



In particular, make sure you have the following:

- Good departure conditions
- Waste management
- Good work light
- Heating and ventilation, if required
- Work tables must be at the right height
- There must be room for technical equipment for moving heavy objects
- Process ventilation with exhaust outlets to the outside should be established for work where dust, fumes or vapours that are harmful to health are generated.
- With noisy work, it must be ensured that others on the construction site are not exposed to unnecessary noise. Noise must be attenuated in relation to what is technically possible. If the noise is still too high, ear defenders must be used.

WORKING ON ROOFS

Personnel need to be secured if there is a risk of injury from falling from the roof.



Materials and tools must be secured against slipping or being thrown down by the wind.

Work at or on eaves etc. can be secured with scaffolding.

When choosing safety measures, emphasis must be placed on the nature of the work, weather conditions, the nature of the roof surface, what you can fall into/onto and a combination of the above factors, etc.

Holes in the roof surface must always be secured with guard rails or sustainable covering.

Flat roofs below 15 degrees

It is necessary to set up guard rails along the edge of the roof if work is being carried out or workers are on roofs with a pitch of less than 15°, and if at the same time the edge of the roof is more than 3.5 m above ground level.

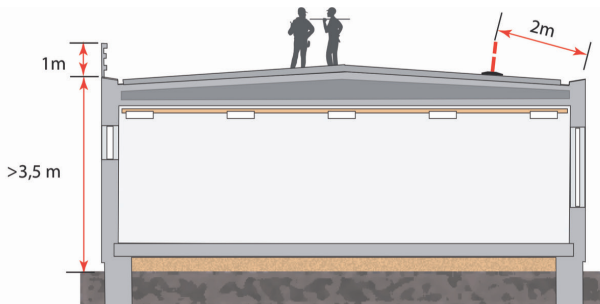

If work is being carried out on a non-slip surface and in good wind and weather conditions, it is possible under special conditions to decide not to establish guard rails at up to 5 m above ground level.

Be aware that regardless of height, special precautions must be taken to prevent falling when there is a particular risk of falling or if falling on the surrounding surface is associated with special danger (e.g. falling on rising objects, materials or in basement necks, etc.). Likewise, the risk of falling and falling through into the building must be counteracted.

It is possible to replace the railing with a clear and durable marking at least 2 m from the edge of the roof if the work does not require getting closer to the edge than the 2 m. In this case, do not move or place materials outside this marking.

The marking must at least consist of cones with marking strips, chains or the like in between. Barrier tape must not be used.

If the top of a wall is to act as a guard rail, it must be at least 1 m high.

Sloping roofs above 15 degrees

When working on sloping roofs, protection must be provided against falling at the base when the base is more than 2 m above the ground and there will be work or traffic at a height of more than 5 m above ground level. In addition, it must also be ensured against falling at gables and must be secured against falling and falling through inside the building.

If scaffolding is used for safety when working on pitched roofs, this must be provided with a screen which can arrest the fall of anyone falling from the roof. This screen must be at least 1 m high and cover a parallel line 1 m above the surface of the roof. Use e.g. steel mesh, plywood sheets or similar.

The work deck of the scaffolding must at the most be 0.5 m below the base of the roof.

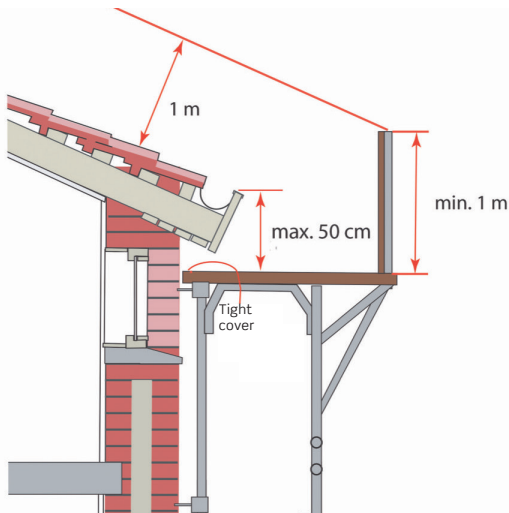

2. SITE PLAN

Additional requirements

Please note that basement necks, light boxes, stand-up objects, etc. that constitute a hazard in connection with a fall will in all cases require safety measures – regardless of the height of the fall.

Roofs with a pitch of 15° or more:

Use roof ladders if battens are slippery. New battens should be C 18 (3.8 x 7.3 cm).

Roofs with a pitch of 34° or more:

Set up a screen so that no employee is working at any time more than 5 m vertically from the nearest screen.

Always use roof ladders, unless it is possible to walk on the battens.

Roofs with a pitch of more than 60°:

Set up screens so no employee is no further than 2 m from the nearest screen.

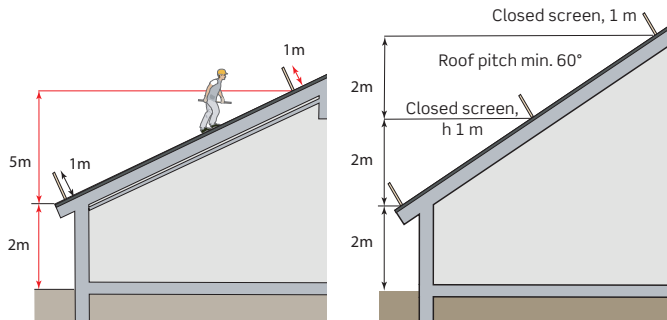

Always use roof ladders, unless walking on the battens is acceptable.

Requirements for railings for roof work

General	<p>The requirements are divided into classes according to the slope of the roof. The guard rails must at minimum comply with the requirements in the EN/DS standard 13374 for temporary railings.</p> <p>Guard rails under this standard are divided into classes A, B and C. See more about this in the table. If guard rails are chosen on site, they must comply with the same requirements.</p>
On horizontal roof surfaces	<p>Guard rails used as protection against falling at the roof edge must - whether it is a system guard rail or a guard rail constructed on site - be sufficiently strong and well constructed to effectively prevent a person from falling</p>
Roof pitch 0-10 °	<p>Guard rails (class A) must consist of a handrail at a height of 1 m, a knee rail at a height of 0.5 m and a foot rail. The foot rail must be at least 150 mm high, but can be avoided where there is a cap/top edge of at least 150 mm.</p> <p>If railings made of wood (good quality) with a dimension of 32x125 mm are used, the load requirements can normally be complied with using a sceptre distance of 2.25 m. The wood is strength sorted on the construction site, so that wood with large throughgoing knots etc. is sorted out. This is a task that requires separate training and instruction.</p>
Roof pitch 10-15 °	<p>System guard rails (class B) must consist of a hand rail at a height of 1 m, a knee rail at a height of 0.5 m and a foot rail. The foot rail must be at least 150 mm, but can be avoided where there is a cap/top edge of at least 150 mm.</p> <p>Openings between strips must not be more than 25 cm. If the railing is made on site, this can be done with an extra knee rail.</p>
Roof pitch above 15 °	<p>System screen (class B) consisting of a hand rail at a height of 1 m, a knee rail at a height of 0.5 m and a foot rail with openings between the rails at a maximum of 25 cm, or an extra knee rail inserted, can be used if the vertical drop height down the roof surface does not exceed 2 m.</p> <p>If the drop height exceeds 2 m, class C screens are used, where the distance between the rails must not be more than 10 cm. In practice, this means using a panel or similar.</p>

Railings and screens constructed on the construction site

Railings and screens made at the construction site must be constructed in accordance with EN/DS standard 13374 on temporary railings or at least at an equivalent level of safety.

Wood used for railings and screens must be of good quality and without large, continuous knots or anything that can reduce the strength of the wood. According to the standard, at least class C16 wood or wood of at least the same quality must be used.

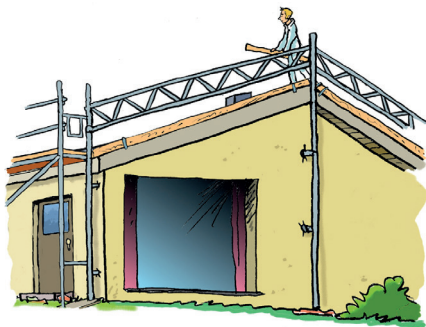

Railings at gable ends

A Class A railing with a hand rail at a height of 1 m, a knee board at a height of 0.5 m and a foot board at a height of 15 cm - where the openings between hand, knee and foot boards are not greater than 47 cm - will in most cases provide sufficient protection against falling from gables on roofs.

A railing with a sceptre distance of not more than 2.25 m can - as an alternative to the standard requirements for calculation or testing with static load - be constructed under the following conditions:

- The railing must be able to withstand a person leaning against it or falling into it and must be able to provide support when standing on it.
- Hand and knee boards must be installed of at least a 32 x 125 mm wood panel and the foot boards of 32 x 150 mm wood panel.

- Place the hand board at a height of 1 m, the knee rail at a height of 0.5 m and the foot board must fit tightly to the ground. Openings between them must not exceed 47 cm.
- The railing must be able to absorb at least 300 N (30 kg) of force on all parts of the railing, both horizontally and vertically, with a maximum deflection of 55 mm. With the foot board, the force is reduced to 200 N (20 kg). In addition, the railing must also be able to absorb a vertical force of 1250 N (125 kg) with a maximum deflection and deflection of 300 mm.

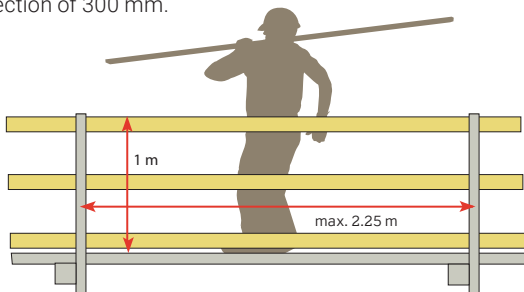

Requirements for railings and roof screens for roof pitches above 15 °

Where there is a particular risk of falling materials or tools, a sufficiently high, denser cladding must be placed – a so-called roof screen, which can e.g. be a mesh or panels.

Railings and screens used to safeguard people from falling must be sufficiently high, strong and well constructed to effectively prevent a person from falling.

A Class B screen with a height of at least 1 m - where the openings between hand, knee and foot rails are not greater than 25 cm – will in most cases provide adequate protection against falling at the eaves from roofs with an inclination of up to 30 ° and on roofs with an inclination from 30 to 34 ° if the vertical height of fall down the roof surface does not exceed 2 m.

2. SITE PLAN

If the drop height exceeds 2 m, a Class C screen - where the openings in the screen do not exceed 10 cm - will in most cases provide sufficient protection against falling from the eaves.

Screens for protection against falling from the base of the eaves can be established by installing durable plywood panels on the inside of the railing or fixed steel mesh. It is a prerequisite that the screens are positioned at an angle of 80-90 ° to the roof surface and that they have a minimum height above the roof surface of 1 m.

Screens made on site to prevent falling at the base of the roof must be able to effectively stop a person slipping or falling down the sloping roof surface. The screens must therefore be able to absorb dynamic loads.

Class-B equivalent screens must be able to absorb at least 1100 J of energy everywhere in the bottom and at the top 500 J of energy while still protecting against falling.

Class-C-like screens must be able to absorb at least 2200 J of energy everywhere in the bottom and at the top 500 J of energy while still protecting against falling.

Working on existing roofs

Carefully examine the structure and load-bearing capacity of the roof before commencing repair or rebuilding work.

Never go directly on top of old roofing panels without establishing protection against falling through when the lath distance exceeds 46 cm from the top edge to the top edge. Also be aware of the condition of the battens, e.g. in relation to advice and drill bits.

If the battens are not sustainable, they must be replaced with strength sorted battens marked C18 with the manufacturer's name and be CE marked.

When laying new roofing panels, work must be planned by including the supplier's safety instructions to prevent them from falling through and falling.

Walkways with guard rails towards the open roof can protect staff from falling through. Hang a safety net between walkways. Never use a safety net as the only safety measure. It will not stop you falling through the roof.

Fall prevention must also be done by covering holes in the roof with load bearing panels and by establishing guard rails and roof screens at the exterior edges of the roof or in other equally as safe ways. It may often be necessary to combine several safety measures. Collective measures take precedence over individual protection, but in some cases it may be necessary to supplement with suitable individual fall arrest equipment.

Thatching bridges

Use safe thatching bridges to increase safety and avoid wear and tear. Thatching bridges and platforms should generally be horizontal so that it is easy to move about on the roof.



FALL PREVENTION

Safety nets

Safety nets should never be used as the only safety measure when working on already existing roofing as they will not prevent you from falling through the roof. In the event of a fall into a suspended net, there is a risk of hitting other objects.

When using safety nets, it is important to use nets designed for the purpose.



Depending on their type and installation, safety nets can be used to safeguard against injury, the risk of people falling and the risk of materials, tools, etc. falling.

A net with a close mesh must be used to provide safety from falling materials, tools, etc.

2. SITE PLAN

Safety nets must be installed and used in compliance with the supplier's usage instructions. Take care not to confuse dust nets with safety nets.

If safety nets are used to protect people from injury in connection with falling, a plan has to be compiled which indicates how to bring someone who has fallen back up or down to ground level.

The net must hang completely freely if it is to act as a safety net for workers as well. Materials or other objects must not be placed under the net, which must be designed and type-tested in accordance with the applicable norms and standards, and fitted with a manufacturer's plate stating their use.

The supplier's instructions for the use and maintenance of the net must be kept on site.

Suspension of nets

Attachment points for the net should be planned and established when the building structure is erected.

Using a personnel lift is ideal when suspending the net. Hang the net up as close as possible to the area beneath the work area. The net must be secured to building elements that can withstand the force of a person falling into the safety net.

Hang up the net so that it has the clearance specified on the manufacturer's plate. Goods must not be stored under the net that reduces ground clearance in the event of a fall. The same applies to personnel or vehicles passing under the net or during suspension of cables and the like.

Protect the mesh from welding sparks, etc.

Follow the supplier's instructions for suspension, inspection and maintenance.

Open façades

It is practical to use guard rails, which can easily be removed if cranes are to unload materials or if facade elements are to be installed.

If there is a risk of falling while working with dismantling guard rails, etc., fall arrest equipment must be used as a minimum.

If a transversal space blocks a passageway, a so-called "pulpit" must be set up. Also remember to set up guard rails at the edges of the "pulpit".

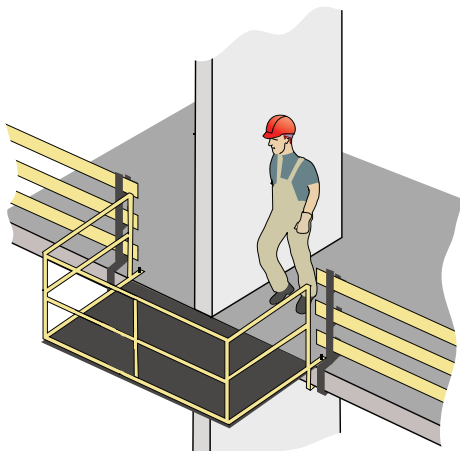

Precast panel installation

When installing elements, always protect against falls. This applies to installations such as edges, floors, window and door openings, shafts, etc.



Replacing windows



When the lower edge of the window is more than 2 m above ground level, use a work platform such as scaffolding, a lift or other form of standing arrangement. If the windows are installed from the inside, ensure that they do not fall out. Always ensure proper transportation of the windows to the places where they are to be installed. Suitable technical equipment must be used for both horizontal and vertical transport and for fitting the windows.

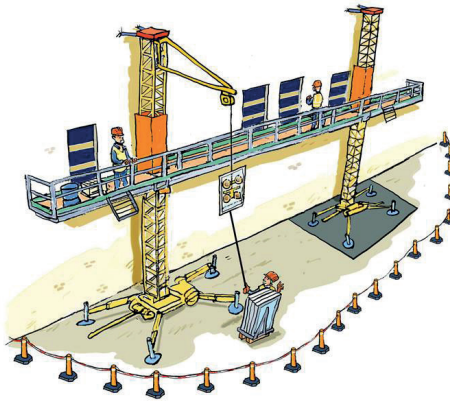

Replacement of balconies

There must be scaffolding or another base at the most 10 cm below the balcony when demolishing cast balconies. The scaffolding must absorb the shock in the case of collapse (normally twice the weight of the balcony).

Screen off the working area so that fragments of concrete from the work do not constitute a risk.

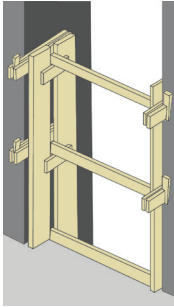

Door openings

Always fit guard rails in door openings in stairwells and lift shafts.

Risk of falling to a lower level

Openings and holes in buildings and excavations etc. which present a risk of falling or falling must be protected with guard rails, covers or other suitable safety measures.

Always set up a guard rail or other effective barrier if there is a risk of falling from the work level, work platform, access route, etc. When working at heights from approx. 2 metres, the height itself constitutes a risk of injury from falling.

Even if the height is less than approx. 2 m, you should always establish protection against falling:

- If the nature of the work presents a particular hazard, e.g. through sandblasting and high-pressure cleaning
- If it is particularly dangerous to land on a surface due to protruding reinforcement rods or stacked materials etc.

If openings are covered with tarpaulin, there must also be hand, knee and foot rails.

Plan the construction so that during the design phase it is already taken into account that inserts must be embedded in concrete elements, sheet piling, roof cassettes, etc., so that it is possible to install guard rail posts without having to drill holes for these.

Holes in floor decks and changes of level in access routes, etc.

Cover all holes or screen them off if there is a risk of anyone tripping over them or stepping through them, or if materials could fall through. This is applicable irrespective of how large the holes are and where they are located. Secure the cover against movement and can withstand the planned loads.

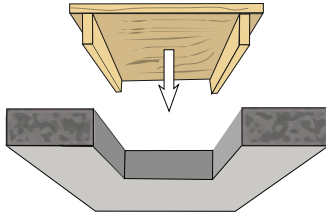

Likewise, all changes of level where people move around should be screened off or marked so that people do not fall or trip.

Large holes

Set up guard rails or supply a clear, durable marker at least 2 m from large holes. Safety strips are not a durable solution.

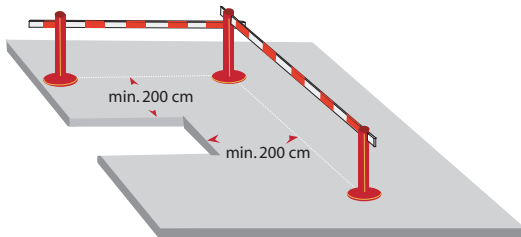

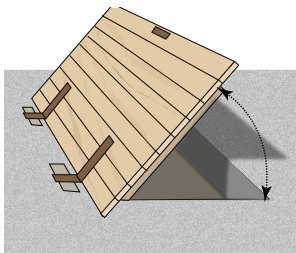

Smaller holes

It is possible to cover smaller holes with a trapdoor provided with battens so that it cannot be pushed aside. Put hinges on the hatch so that you cannot remove it, but still use the hole, e.g. to transport materials.

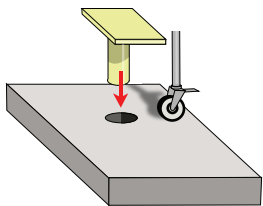

Small holes

You have to cover small holes yourself if:

- risk of tripping
- using moving technical equipment
- there may be a risk of objects falling down through the holes and hitting people on the underlying floor or area.

Skylights

Holes that are to be turned into skylights have to be covered with a load-bearing, non-slip material which remains in place.

Alternatively, they can be secured using guard rails or clear, durable markers at least 2 m from the edge.

Non load-bearing surface

Do not work on surfaces that are not load bearing. This may, for example, include points where joists, roof panels and similar cannot withstand people walking on them. It must be secured against stepping or falling through.

LIGHTING



The orientation lighting must be described in the Health and Safety Plan (HSP). Both this document and the tender documentation must state which part of the lighting individual contractors are responsible for.

General

Place light switches as close to the entrance as possible. If orientation lighting is necessary but has not been installed in working areas or rooms, it must be possible to switch on work lighting at the entrance to the area or room.

Where the light is always on, the switches must be fixed so the light cannot be turned off by mistake. If necessary, use a key switch.

Divide the lighting into as many electricity groups as possible so one blown fuse cannot plunge whole areas into darkness.

Consider whether there are areas on the construction site where emergency lighting and lighting of escape routes will be necessary.

Rooms without light must be cordoned off if there is a risk of falling or being injured in any other way. Other rooms or areas which have insufficient lighting can be either cordoned off or marked.

Provide a cabinet with spare fuses and lamps in a readily accessible location.

Non-dazzle lighting

Lighting must never dazzle, cause reflections or cause uncomfortable heat. Always apply light from at least 2 sides. This helps to prevent deep shadows.

Risk of fire and risk of electrical accidents

Keep fittings clean and in good condition. Remember to replace the protective grilles when replacing light sources.

Fittings to be used outdoors must be designed for this purpose. An incorrectly selected list fitting can cause an electrical accident or fire.

Think about the positioning of lamps. If they have a high surface temperature, they may start a fire. Therefore, never place them on the floor; there is a major risk there of them coming into contact with highly inflammable materials. LED light sources are recommended. Lamps which do not have double protection must have earth connections at their connection points.

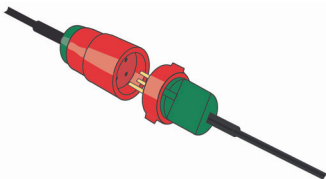

Sockets and plugs must always fit together to provide a safe earth connection.

Note that each contractor is responsible for their own work lighting.

Orientation lighting

Orientation lighting is the lighting necessary to allow people and vehicles to move safely around the building site. It must be at least 25 lux.

Work lighting

Work lighting is the lighting necessary to allow employees to do their jobs safely. The lighting must be suited to the type of work.

Measurement and assessment of lighting

It is possible to measure the strength of lighting using a luxmeter. The lux unit is a measure of how much light falls on a given surface.

2. SITE PLAN

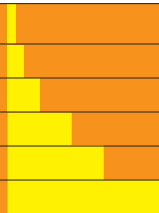
Orientation light	25 lux	
Rough work	50 lux	
More demanding work	100 lux	
Covered work area	200 lux	
Installation work	300 lux	
Precision work	500 lux	

Note that the older a light source is, the less light it gives off. It is therefore a good idea to choose a higher lux value than those stated here.

ELECTRICITY

General information on building site installations

Construction site installations must comply with the requirements of the Executive Order on Installation and the DS/HD 60 364 standard series.

The HSP must state who the developer has engaged for the maintenance of the electrical installations in the shared areas of the construction site.

Newly established electrical installations must be reported to the local electricity grid company by an authorised electrician. This applies to both temporary and permanent installations.

If a temporary installation on the building site is retained for more than three months, the installation must be inspected every three months by an authorised electrician. The user, in this case the developer of the temporary installation, is responsible for the condition and maintenance of the installation.

Building site power supply

Electrical cables which power main or subsidiary switchboards must be protected from damage. They can, for example, be suspended, buried or protected in some other way.

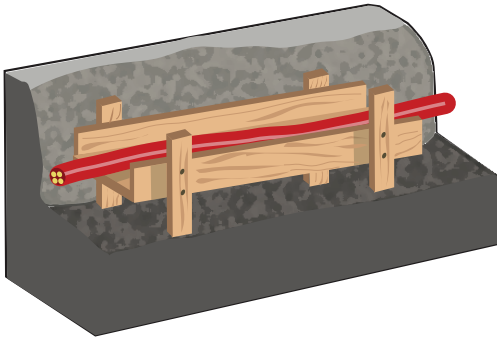

To avoid damage, do not place power supply cables on transport or pedestrian routes. If this is unavoidable, the cables must be protected against mechanical overload. For example, cables can be buried under the carriageway.

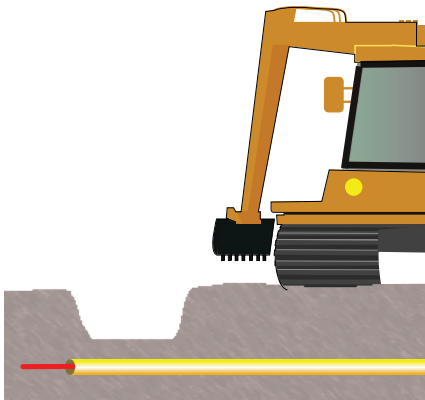

2. SITE PLAN

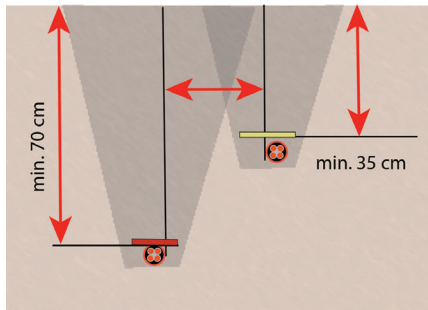

If the cables are buried, they must be located at a depth of at least 35 cm and be protected with conduits, U-profiles or plastic cover plates. Unshielded cables must be buried in min. 70 cm and covered by a warning tape.

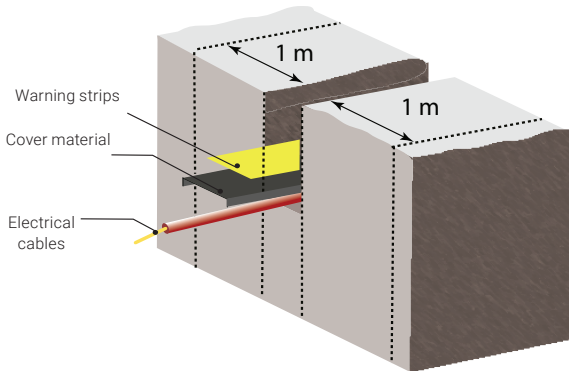

There is 1 m excavation-free area on each side of the cable.

Cables and wires can also be hung on masts, building parts, scaffolding, trestles, etc. In these instances, they must be secured with insulated material. When using suspended cables make sure they are clearly marked and hung away from roads and walkways and are hung high

enough so excavators, trucks and other machinery cannot collide with them.

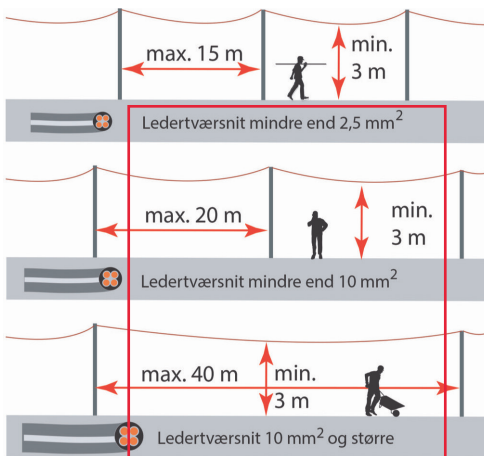

Temporary installations must be positioned in such a way as to require as little as possible relocation.

Flexible cables, apart from supply cables (cables on electrical devices and extension cables) must at minimum be sheathed and heavy-duty – type H07RN-F or equivalent.

Construction site switchboards

Construction site switchboards must be CE-marked² and comply with the requirements in DS/EN 61439-4 and be marked accordingly. This information will often appear on a label on the board along with information about serial numbers, etc.

Construction site switchboards must be secured so they can not tip over and must be positioned in such a way that they are accessible and can easily be operated. The area in front of the switchboard must be

2. SITE PLAN

tidy. Ensure that there are enough building site switchboards located close to the points of use to avoid excessive cabling and loose wires.

Sockets in building site switchboards must have a residual current device (RCD/HPFI breaker).

If a fuse interrupts the power, a new fuse may only be replaced once. If it also cuts off the power, call an electrician. This also applies when reconnecting automatic fuses.

It has to be possible to interrupt the power supply to the building site. Therefore, there must be lockable switches in all construction site switchboards.

Appliances and tools

Appliances connected to installations on the construction site must be double insulated or class 01 (with earth conductor).

Plugs must normally be fitted with earthing contacts which are connected to a protective wire. These plugs can be ordinary Danish earthed plugs, earth pin plugs or industrial plugs.

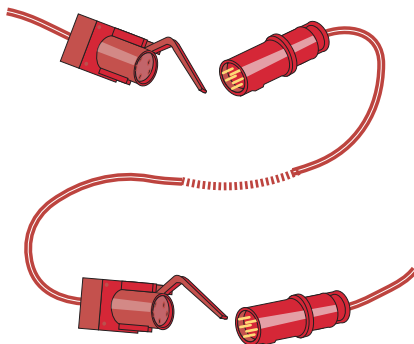

This is also applies to cable reels and similar. In this case, both the plug and the socket component must have earthing contacts.

You must only connect appliances to the voltage and current for which they are designed. They may be connected by inserting a plug in a socket or by means of a wired-in connection, as is the case with e.g. cranes and similar. Only authorised electricians may install wired-in connections.

There should be a lockable switch (isolation switch) in front of permanently connected utility items.

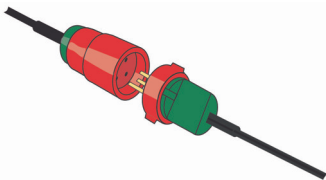

Sockets and plugs must always fit together so that earth connection is made safely in class 01.

Plugs, sockets and extension sockets must have high mechanical strength, e.g. two-coloured (red/green). Only one cable must run from a plug or extension socket.

Wires must not be exposed to covers and must be secured against pinching and penetration of sharp edges, etc. Do not put several extension cords in succession, as there is a risk that a short circuit may occur without the fuse blowing.

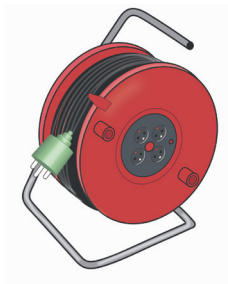

Cable drums shall be sufficiently solid, at least mantle lines in heavy construction type H07RN-F or equivalent wear and water-resistant cables and have a protective conductor and earth pin/earth contact.

Remember to unwind the cable completely from the drum. Failure to do so may cause the coiled cord to melt (burn).

2. SITE PLAN

Contractors must ensure that electrically operated hand tools are inspected:

- according to the manufacturer's instructions
- regularly, usually once a year, but depending on the application
- by visual inspection of the tool before use.

WATER PIPES

To avoid damage to water pipes, they must be suspended or buried. Prevent personnel from tripping over water pipes which have to be laid on the ground or floor. Also protect them from damage.

It is particularly important in winter to ensure that water supply pipes are insulated and frostproofed so that water can continue to run through them.

Prevent frost problems with water installations and drains:

- Supply taps to the water installations so that the water line can be emptied of water when not in use. Empty the water out of water pipes and hoses when everyone goes home or if work comes to a temporary halt.
- Hoses should be coiled and stored in a frost-free room.

WASTE

Waste and empty packaging must be placed in specially designated areas or in containers which are emptied regularly.

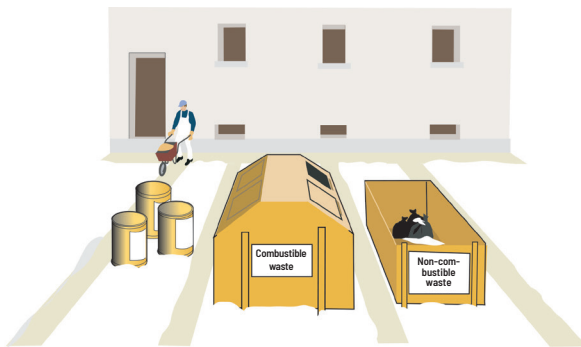

Materials and waste have to be disposed of in accordance with the waste regulation for the municipality in question.

Materials and waste must not be positioned such that water, snow and mud cannot be removed.

Please note that there are special rules and precautions regarding waste management of asbestos, epoxy and isocyanate products and PCBs. This includes spills, empty packaging, used workwear, etc.

WINTER MEASURES

For weather protection, stationary workplaces (e.g. iron binding, sawing with stationary circular saws, cutting pipes, etc.) must be established in containers, under a canopy or indoors, regardless of the season.



During the winter period, you must protect against water, rain, hail and snow, as well as cold and darkness.

2. SITE PLAN

During the period from 1 October to 31 March, *the Danish Working Environment Authority's rules* in the Executive Order on the organisation of construction sites stipulate requirements for winter measures to protect employees.

Raw materials must be covered on scaffolding, work platforms and in open structures:



- if the work lasts over a longer period of time (in building shells, around three days and on scaffolding etc. six days)
- if the weather is so bad that employees risk being exposed to adverse health effects
- if flashing is possible and a reasonable option

The Danish Transport, Construction and Housing Authority's rules on winter work apply during the period from 1 November to 31 March for the protection of buildings and materials.

The collective agreements have guidelines on payment for implementation of winter arrangements and guidelines for the supply, setup and moving of shelters.

The building regulations require that it must be possible to carry out building work in the dry. This may mean that covers have to be used.

Make sure that drain laying and drainage work are carried out in plenty of time before the winter.

Roads and storage sites must be drained effectively.

Supply conduits (electricity) and pipes (water) must be laid in plenty of time. Temporary water and sewage pipes must be frost protected.

Acquire shovels, snow ploughs, sweepers and other snow clearing equipment in plenty of time. Also remember grit, urea salt and winter mats. These may also be placed in a store.

Review your winter arrangements at a meeting in plenty of time before the onset of winter.

Examples of possible measures:

- Closing of facade openings with plastic covered frames, etc.
- Full or partial covering with plastic tarpaulin, etc.
- Flashing in the form of an efficiently designed building envelope or wind deflector
- Cover or total cover
- If a plastic tarpaulin is to be fitted to the scaffolding, it must be securely attached
- If the scaffolding is covered with nets, the same number of cords as the tarpaulin cover are not required. A net that limits the wind impact by up to 50% will ensure visibility and can therefore in some cases be a sufficient and acceptable solution
- Removable flashing – possibly with heating.

Working temperature

In winter construction, the building must be closed as soon as possible to avoid unnecessary cold exposure and draughts.

The working temperature must be adapted to the human organism in relation to the working methods used and the physical load applied in the work.

In winter, for example, the temperature can be adjusted by heating up workplaces in buildings. Normally a room temperature of about 10 ° C will be suitable for active physical work.

For stationary precision work, a temperature of around 15° will be appropriate.

If the temperature cannot be adjusted, e.g. because the work takes place outdoors or in a workshop without the possibility of local heating, the requirement can be complied with in full or in part by the employer

2. SITE PLAN

ensuring that the employees are provided with warm workwear – e.g. also when working on covered façade scaffolding etc.

Note that it is not the entire building that needs to be heated, but only where work is being carried out. For example, in large buildings it is possible to screen/cover the actual workplace so that it is not the entire building that needs to be heated in connection with delimited tasks.

WORKING AT HEIGHT

When planning a construction job at height or at depth, it must always be determined which aids are necessary to carry out the work in a fully responsible manner. This includes which tools and equipment are most safe and most suitable in terms of health and safety for the task, e.g. a choice between scaffolding, personnel lifts (lifts) or ladders.



Among other things, check:

- there are user instructions/set-up instructions etc. at the work site
- there is space to transport the tools and equipment before and after completion of the work;
- access and transport routes are good and practical
- there are special risks associated with the use of some tools and equipment
- everyone has received training
- qualifications for working with certain tools and equipment (e.g. certificate requirements, age limitation, etc.)

FACADE SCAFFOLDING

Facade scaffolding must be suitable for the tasks to be performed on the scaffolding, e.g. by several different professional groups. This includes load-bearing capacity, width and height. The site must always have user instructions in Danish and other languages understood by the employees that show what the scaffolding may be used for and how it may be erected.



The scaffolding should stand on a firm base and be secured against tipping over. If the scaffolding needs to be chocked up, the block must be stable and no more than 20 cm high and must be of wood or similar material that cannot be crushed under a weight. If, for example, several pieces of timber are used as chocking, they must be held together, e.g. nailed together.

3. CRANES, LADDERS AND SCAFFOLDING

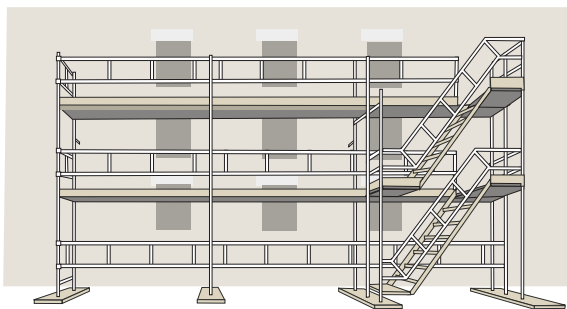

This can be done by securing the scaffolding in a safe way to the façade/structure. Follow instructions for use for securing scaffolding.

Scaffolding components must not be deformed or rusty, and the individual parts must fit together.

Persons who are to erect, modify or dismantle scaffolding higher than 3 m must have the necessary training.

Transport

Initially use pallets, still-ages and frame containers when you are going to move the elements of the scaffolding from a storage site to a vehicle and from the vehicle to the site where the scaffolding is to stand.



As a starting point, the handling of materials from lorries to installation sites must be handled with a telescopic loader, crane or other technical aids so that the handling can be carried out in a safe and healthy manner in accordance with the Danish Working Environment Authority's rules on manual handling.

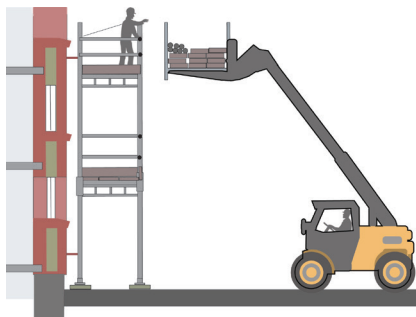

When hoisting the scaffolding parts up and down, use suitable lifting gear. A base mounted electric hoist with a raised hoisting bracket or a scaffold hoist can be used.

Hand hoists will only be suitable for fitting and dismantling of plastic, nets and waste chutes. Hand hoists must be equipped with brakes. However, if it is not possible and appropriate to use other suitable technical aids, a hand hoist can be used for vertical transport of certain scaffolding components and not for ordinary scaffolding installation.

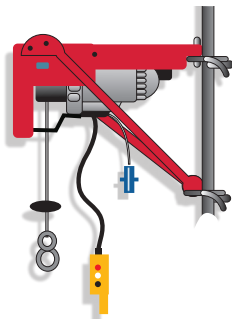

Erecting scaffolding

Use only intact original elements or elements you can combine safely. Follow the requirements in the guide when you erect, strengthen and secure the scaffolding.

Particular risks

If brackets, screens, plastic or mesh are fitted to the scaffolding, the number of securing points must be increased, cf. the usage instructions.

3. CRANES, LADDERS AND SCAFFOLDING

A design calculation and user manual must be made if the scaffolding is erected in other ways than in the standard method shown in the installation manual.

Signs

Scaffolding higher than 2 m must be provided with signs at the access routes to the scaffolding. The company erecting the scaffolding is responsible for ensuring that this takes place.

Signs must clearly show:

- What the scaffolding is to be used for, e.g. window replacement or roof work
- Maximum load with indication of load class (point load and distributed per m²)
- Date of erection
- Date of any last change
- The company that has erected or changed the scaffolding
- Date of inspection before commissioning
- Signature of the expert who carried out the latest inspection.

The information on the signs should be updated on a regular basis to reflect any changes to the scaffolding installation.

The latest inspection date must appear on the signs.



Loads on scaffolding deck

Scaffolding is divided into classes, as shown in the load table. The load table assumes that only one scaffolding level may be loaded 100% and one with 50%. The other levels may only be loaded if the scaffolding contractor has granted permission - provided that there are separate

design calculations for this, if the scaffolding has not been erected in a standard set-up.

Scaffolding class	Surface load	Concentrated load = 500 x 500 mm	Concentrated load = 200 x 200 mm	Load on partial area = tread width x tread length	
	kg/m ²	kg	kg	kg/m ²	Concentrated load/m ²
1	75	150	100		
2	150	150	100		
3	200	150	100		
4	300	300	100	500	0.4 x part area load
5	450	300	100	750	0.4 x part area load
6	600	300	100	1000	0.5 x part area load

Classes 1, 2 and 3 – lightweight façade scaffolding: 1 and 2 are used for inspection, 3 for lighter work without material storage.

Classes 4, 5 and 6 – heavy steel scaffolding: 4 and 5 are normally used for masonry and concrete work, and window replacement, 6 is used where large quantities of material are stored.

Scaffold widths

The scaffolding (work deck) must be of a width which allows work to take place properly and ergonomically correctly and which allows the necessary technical aids to be used.

If the width of a floor is only approx. 60 cm, only light repair and maintenance work must normally take place on the deck.

The width must be 120 cm when windows are being replaced or personnel are working with high pressure washers. See more about scaffolding widths in the industry guide on standard blades for system scaffolding.

3. CRANES, LADDERS AND SCAFFOLDING

(Width of scaffolding deck incl. footboard)

Typical Workflows	Width class	Width (w)
Façade work, e.g. inspection, painting and minor repair work (standing work)	W06	$0.6 \leq w < 0.9$
Façade work, e.g. painting work, minor repair work (standing work) and where materials must be transported on the scaffolding - any brackets must not be displaced from the main deck	W09	$0.9 \leq w < 1.2$
Façade and roof work, e.g. filing, pointing, light plastering, window replacement, sandblasting, high-pressure washing and kneeling work	W12	$1.2 \leq w < 1.5$
Typically used on parts of the scaffolding, e.g. when adjustments are needed in relation to the façade or where many simultaneous work processes are carried out	W15	$1.5 \leq w < 1.8$
Typically used on parts of the scaffolding, e.g. when adjustments are needed in relation to the façade or where many simultaneous work processes are carried out	W18	$1.8 \leq w < 2.1$
Bridging and roofing work	W21	$2.1 \leq w < 2.4$
W24 is used for scaffolding erected as platforms, e.g. chimney scaffolding	W24	$2.4 \leq w$

Ascents



The scaffolding must be fitted with steps or ladders to be used for climbing up the structure. There must be a separate stairwell or stairwell at scaffolding where more than two people are working at the same time. This is applicable if the scaffolding is more than 5 m tall and more than 10 m long.

There must always be at least two escape routes from a scaffolding installation so that everyone using the scaffolding has the opportunity to get to safety in the event of a hazardous situation.

Access from the stairway to the scaffolding deck must be unobstructed and level and at the same level. The stairway should also reach the top deck. Access holes in the scaffolding deck must be secured with a hatch that can be closed.

Distance to façade

Scaffolding must be placed as close to the building as possible to allow work to be performed on the façade from the scaffolding. If the distance to the façade is more than 0.30 m, there should be internal guard rails.

Walk-through height on a scaffolding

Clear opening height must be minimum 190 cm – measured from deck to deck.

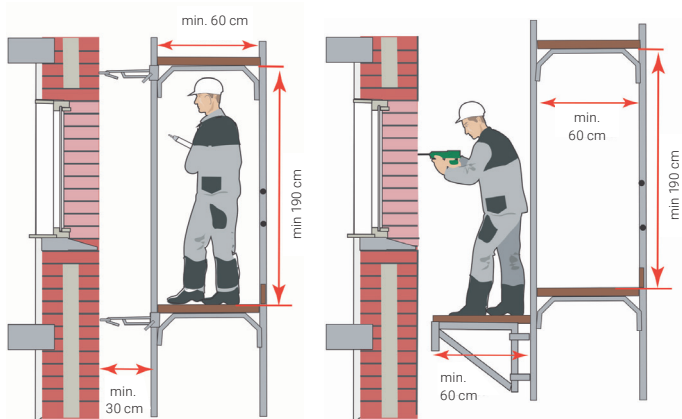

Guard rails

When there is a risk of falling and injury from a scaffolding deck, railings must always be set up. This applies to heights of approx. 2 m to ground/surrounding ground, as the fall height (length) in itself constitutes a risk of injury. Guard rails consist of a handrail at a height of 1.0 m, a knee rail at a height of 0.5 m and a foot rail of at least 0.15 m.

3. CRANES, LADDERS AND SCAFFOLDING

Screening

Make a barrier or screen, or mount nets that can prevent building materials or equipment from falling from the scaffolding.

Scaffolding decks

The scaffolding deck must be load-bearing and rigid, and it must fill the entire scaffolding. It must be dimensioned and built in accordance with applicable norms and standards. The necessary strength, rigidity and stability must be assured. Avoid having overlaps in the scaffold floor as there is otherwise a risk of people tripping and falling over them. If overlaps cannot be avoided, they must be at least 25 cm. Wedge-shaped pieces facilitate operation with wheelbarrow and stone carriage.

WORKING ON SCAFFOLDING

Scaffolding for roof work

 When working on the roof, the distance from the eaves to the scaffolding deck must not exceed 0.5 m. In addition, there must be a tight covering at the top scaffolding deck in to the facade.

If scaffolding is used for safety when working on pitched roofs, this must be provided with a screen which can arrest the fall of anyone falling from the roof. This screen must be at least 1 m high and cover a parallel line 1 m above the surface of the roof. Plywood boards can be used for this, for example.

When working on the roof, the scaffolding must be broadened to ensure the necessary space, which, for example, can be done using brackets.

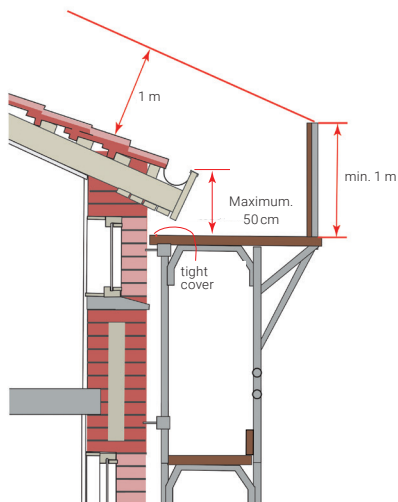

These three points apply to all scaffolding work:

- Scaffolding (column ends, horns, etc.) must not be stowed on the scaffolding deck
- All hatches must be closed when working on scaffolding
- Trestling, boxes, ladders, loose construction elements, etc. must not be used to increase the working height.

Particular risks

Veneer should not be used to extend the scaffolding deck without being supported.

- Veneer can be used to establish solid scaffolding decks
- Veneer must be min. 22 mm thick
- The maximum bend of scaffolding decks should at most be 30 mm.

If erection and use of the scaffolding takes place on and by public roads, the work will also be covered by the road regulations. A signage plan must be drawn up and approved by the road authority. The

3. CRANES, LADDERS AND SCAFFOLDING

signage plan must show in detail where the signage is to be set up, which signs, etc. are to be used and how the scaffolding is secured against collision. The signage plan must be approved by the road authority before work commences.

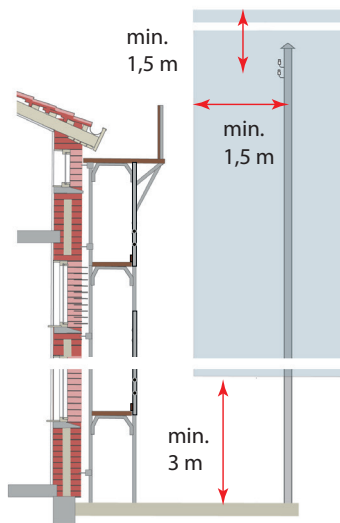

If there are overhead cables so close to the scaffolding that workers come within the statutory safe distance (see drawing), the electric cables must be insulated to prevent contact or the power must be switched off. Only qualified personnel from e.g. the local utility company may make live cables safe. The measurements in the drawing are minimum figures.

Working near transmission masts

Antennae for, for example, mobile telephony, create electromagnetic fields (EMF) that can be harmful to health. If work is to be carried out within 8m of a mobile telephone antenna, the building owner or mast owner must be consulted about the required separation distance from the antenna in question. If it is necessary to work within the respect distance, the antenna must be switched off.

Employees must be instructed to keep traffic near the antenna to a minimum.

Covers

Protection against falls when installing tent covers

Tent covers must be constructed under conditions that take health and safety into account to the extent necessary. Employees must be particularly protected against falls and collapse during construction work. This can be done, among other things, by constructing the tent cover on the ground and hoisting it up by crane or by constructing the tent cover from a platform at height where the employees are secured against falling and from where the tent cover can be rolled out.

The scaffolding erector must plan and organise the connection to the load-bearing scaffolding in such a way that the employees can work from places where they are secured against falling. Employees must also be secured against falling when carrying out other types of connection work at height. If this cannot be done in any other way, employees must use suitable fall arrest equipment.

Construction of the tent cover at height on site must be planned, organised and carried out with due regard to health and safety. This means that heavy lifting and other hazardous or hazardous handling must be prevented and employees must be properly secured against falls and collapse.

The scaffolding erector must have undergone the occupational health and safety training in the installation of complete solutions.

MOBILE SCAFFOLDING



Erection, modification and dismantling of rolling scaffolding higher than 3 m may only be carried out by persons who have undergone a special 1-day scaffolding training. The height of the scaffolding is calculated from the base/terrain to the upper edge of the top scaffolding deck.

Before erecting the mobile scaffolding, check that all parts are present and intact. Defective and damaged scaffolding parts must be disposed of.

There should also be instructions for use in Danish and other languages understood by the employees. Among other things, it must state the permitted surface load and point load and how to erect and use the mobile scaffolding. The instructions for use should be issued to the employees together with specific instructions in relation to the specific work task.

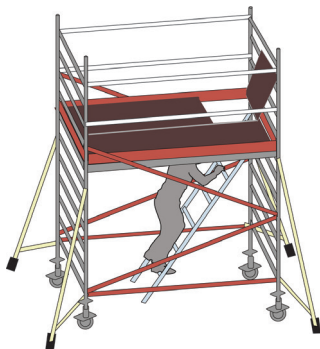

The instructions for use must state when and how to supply the scaffolding with support legs.

Erection, alteration and dismantling

Follow the supplier's installation instructions when setting up and taking down the mobile scaffolding. Instructions for use must always

be available when erecting mobile scaffolding. There must be no risk of falling when erecting, altering and dismantling mobile scaffolding.

The base must be even and sufficiently load-bearing. Mobile scaffolding must be vertical and not be able to tip.

Rolling scaffolding must be fitted with internal steps or ladders to be used when staff have to climb the structure. Other types of mobile scaffolding are equipped with vertical ladders, which can also be used provided that this can be done safely, e.g. that there is no snow or mud on footwear and you are not carrying tools or other materials. The access opening must be at least 0.4 x 0.6 m in size, and it must be fitted with hinged or sliding hatches. The hatches must be closed when people are working on the deck.

There must always be guard rails from a height of 2 metres. There must also be guard rails on lower scaffolding if there is a particular risk of falling or if a fall to the substrate would be particularly hazardous. Guard rails comprise a hand rail at a height of 1 metre, a knee rail at a height of 0.5 metres and a footboard at min. 0.15 m.

The work platform must completely fill the scaffolding both lengthwise and widthwise. The floor must not be able to tip or move, and the wheels must be locked.

The mobile scaffolding must not be secured to other building parts or structures. If the mobile scaffolding needs to be secured, use fixed scaffolding instead.

Working on mobile scaffolding

The brakes must be on all wheels when the scaffolding is in use. The brakes must be easy to operate without using tools.

There must be no people on the scaffolding while it is being moved.

Never use boxes, ladders or other equipment to achieve extra working height.

Movement on the rolling scaffolding may only take place from the inside of the rolling scaffolding. Keep the hatches closed after inspection.

TRESTLE SCAFFOLDING

Erection, alteration and dismantling of trestle scaffolding higher than 3 m may only be carried out by persons who have undergone a special one-day scaffolding training course.

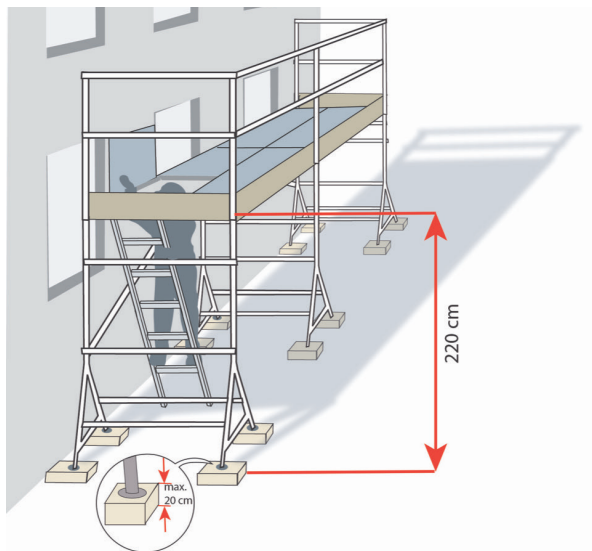

The height of a trestle scaffold is measured from the ground to the top of the scaffolding deck. Blocking-up (max. 20 cm) is included in the measurement of the total height.

When erecting trestle scaffolding with a deck height exceeding 2.20 m, the employer must prepare a written instruction, which together with the manufacturer's instructions, describes how the work can be performed in a completely safe manner. Alternatively, other scaffolding solutions should be chosen.

To prevent physically stressful working positions and the risk of falling, BFA Building & Construction recommends erecting trestle scaffolding with a maximum height of 2.20 m, including chocking.

Before erecting the trestle scaffolding, check that all parts are present and intact. Defective and damaged scaffolding parts must be disposed of. The supplier's instructions for checking and inspecting the scaffolding parts must always be used. Pay particular attention to how the scaffolding parts can be strengthened and inspected effectively for weakening and internal corrosion.

There should also be instructions for use in Danish and the language that is spoken and understood at the site and which explains how to set up and use the trestle scaffolding. This must specify the permitted uniform load and spot load. The user instructions are issued to the employees together with specific instructions in relation to the specific work task.

Erection, alteration, dismantling and use

The supports must stand on a firm and even surface - and in a vertical position so that they cannot tip over.

There must always be guard rails if there is a risk of falling and injury. Guard rails comprise a hand rail at a height of 1 metre, a knee rail at a height of 0.5 metres and a footboard at min. 0.15 m.

The trestle scaffolding must always be installed with a safe access route, e.g. with a fixed ladder or with a landing hatch in the deck in combination with a suitable fixed ladder.

Follow the supplier's instructions for loads when placing materials on the trestle scaffolding.

Never use boxes, ladders or other equipment to achieve extra working height.

The training requirement for erecting a free-standing bending scaffolding higher than 3 m is a one-day trestle scaffolding course.

3. CRANES, LADDERS AND SCAFFOLDING

Trestle scaffolding for roof work

If the trestle scaffolding is used as fall protection in connection with roofing work, the following must be observed:

The width of the top blinding layer must be min. 1.2 m.

The scaffolding must be anchored to the wall and double anchored on each pillar immediately below the top platform. Fasten the anchor to the wall with an eye screw. If wall anchors are used, these are fastened to the horizontal lintel of the masonry block from the inside and outside, respectively, before the platform is installed. To secure the anchor to the vertical column of the lintel, use the pipe anchor with a double fixed coupling 48/34 mm.

Shield boxes (covering the gap at the railing) must be used – either of plywood or approved screen boxes.

The distance from the top edge of the eaves (roof surface) to the top platform must not exceed 50 cm.

The scaffolding must be installed with a tight cover, i.e. the distance from the wall to the platform must not exceed 3 cm.

The rail must be flush with the cutoff line calculated 1 m above the roof pitch (but minimum 1 m).

Double anchor with wall anchor on the wall trestle header. Install anchor before the platform.

WORK PLATFORMS, 1- AND 2-PILLAR



The work platform must be suitable for the tasks to be performed. This applies, among other things, to load capacity and size. There must be instructions for use in Danish and other languages which the employees understand and which describe how to use, operate and maintain the work platform on a daily basis. Before starting work, employees must have verbal instruction and training in the use of the work platform.

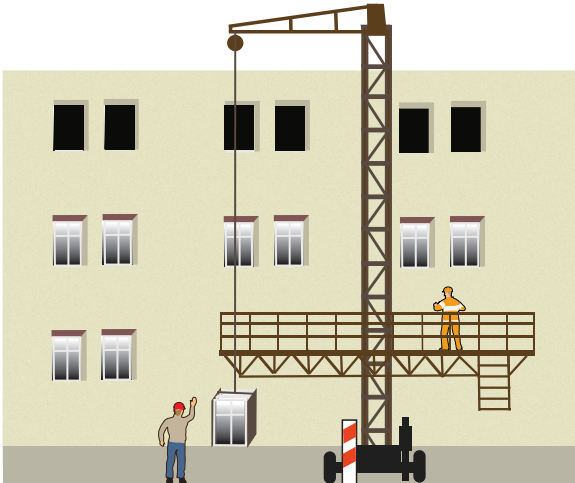

The work platform site must have a clear sign with brief usage instructions. This must state, among other things, the maximum permitted load and the distribution of the load over the platform. Manufacturers' signs on the platform must be intact and maintained so that messages can be seen immediately.

It must be possible to interrupt the energy supply, e.g. with key switch, to prevent unauthorised persons from operating the lift. The platform must not be used as a hoist.

All work platforms marketed after 1 January 1997 must be CE marked and comply with the requirements of the Machinery Directive.

Log book

It must be possible to read the history of the platform in logs kept at or near the work platform. Information on load tests, repairs and inspections must also be provided. The owner of the equipment is responsible for keeping the logs.

3. CRANES, LADDERS AND SCAFFOLDING

The record shall contain information on:

- Approval and type testing
- Load testing, stability, etc.
- Overhaul, repairs, replacement of supports (electric motor, gearbox, rack and pinion)
- Working Environment Authority enforcement notices relating to equipment
- Manufacturer, year of manufacture, name of importer and any certificates for means of carrying (catch/emergency brake).

Inspections

A main inspection must be carried out by the supplier or another expert at least once a year.

Erection

Only persons who have received special training, including knowledge of the manufacturer's instructions for use, may erect, modify, move and dismantle work platforms. The same applies to work platforms designed for continuous moving.

The substrate must be load-bearing and capable of absorbing the compressive forces specified by the supplier.

Chocks must be max. 0.20 m high and stable, and they must be able to absorb the forces present in all directions.

If the mast is secured to a building element, both this and the material used for securing it must be able to absorb the necessary forces.

 If the installation and use of the work platform takes place on and near public roads, the work is covered by the road regulations. Where there is a risk of collision, appropriate measures must therefore be taken.

Moving the work platforms

Work platforms may only be moved if the substrate is firm and load-bearing. In addition, it is necessary to ensure that the mast height does not exceed the supplier's specifications.

The support legs must be raised and locked immediately above ground level when moving.

Use the manufacturer's instructions on wind and weather conditions.

Signs

There must be a sign close to the gate which describes the maximum load as follows:

- Max. load in kg
- Distribution of the load on the platform
- Number of persons and other load (one person is counted as 85 kg)

The control panel must have clear pictograms.

Covering

Only cover the work platform if this has been agreed with the erector and following the manufacturer's instructions. Even a small cover or signs on the guard rail will increase the wind load on the platform. This places higher demands on erection/securing. In terms of flashing, remember the period for winter measures (1 October to 31 March).

Access

There must be easy access to the platform. There must be a fixed stairway or ladder if the distance to the ground is more than 50 cm. Stairs and ladders must have handrails or other support options. The gate on the platform must be self-closing, and it must not be possible to open it outwards. The gate must also have an automatic lock or electrical contact which prevents the platform from being raised when the gate is open.

3. CRANES, LADDERS AND SCAFFOLDING

Railings/barriers

The platform must normally have guard rails on all sides, consisting of a handrail at 1.1 m height, a knee rail at 50 cm height and a footboard at least 15 cm. A guard rail can also consist of a solid plate or net, which must follow the manufacturer's instructions.

When working on façades, the internal railing may be omitted, although, only if the platform floor follows the façade and the distance between the façade and the platform at no time exceeds 25 cm.

There must be clear demarcation, e.g. a chain around the work platform, so that no unauthorised persons can come into dangerous proximity of the work area around the platform and be struck by falling materials or tools.

Floor

The floor must be horizontal and made from a non-slip material. There must be a drain for rainwater, and openings in the floor must be max. 25 mm.

Working on platforms

The load on the platform must not exceed that stated by the manufacturer on the load plate, which must be located close to the access door.

The maximum load must be described as the max. load i kg, the distribution of the load and the number of persons and other load. One person is equivalent to 85 kg.

Minors under 18 may only operate work on platforms if this takes place in connection with industrial skills training, e.g. as apprentices, and only if they have received proper instruction. However, minors under 18 may work from a work platform.

Do not use ladders, boxes, etc. to raise the working height.

The work platform must not normally be left in its raised position. However, if this is necessary, an exemption from the Danish Working Environment Authority may be obtained. Balcony work may be one such example.

In such situations, work decks, work platforms and other access routes must be secured by guard rails or another form of effective protection against falling. The control panel must also have a lockable switch.

Position the platform in its lowest position at the end of the working day. Also remember; the power supply must be switched off and locked.

Particular risks

Uneven weight distribution on the work platform can have fatal consequences. Therefore, pay attention to where materials are placed and distributed on the platform. Distribute the weight evenly.



Set up screening or similar, as there may be a risk of being crushed between the mast and the platform or between the platform and building parts, as well as between the platform and the ground.

No persons are allowed on the pull-out/console deck when climbing or descending the platform.

Avoid hitting open windows and other structures/materials. This may overload the platform, resulting in a risk of collapse.

Emergency preparedness

When working at height from a work platform, at least one person must be present at the workplace, who can call for help to the extent necessary, e.g. in the event of accidents and injuries. The person must be able to be called from the platform by shouting or using a mobile phone.

3. CRANES, LADDERS AND SCAFFOLDING

This person must be trained in the emergency procedures in the emergency response plan.

Contingency plan

A contingency plan is required describing how people in an emergency can be rescued or helped. It is the employer's responsibility to train the employees in the contingency plan and any emergency lowering procedures. In connection with the contingency plan, the following conditions may, for example, be included in the assessment:

- Access and rescue routes to and from the workplace - is there sufficient space to use lifts, crane baskets and similar rescue equipment - and is there room for the emergency services to reach the accident?
- What kind of rescue can be performed and what technical aids are available? E.g. rescue from lift, mobile scaffolding, ladder or by hoisting. Or inside the building, if this is possible from the scaffolding.
- What is the distance to the nearest rescue service in case of serious accidents? Inform the emergency services in advance of any GPS coordinates at the work site. Are there any special conditions at the work site, which means that prior agreements must be made with the emergency manager/rescue service?
- Is there a need for at least two people to work on the platform, as the platform can only be operated and emergency lowered from above? Or is there sufficient technical equipment on site that can be used for rescue or other solutions?

The extent to which an emergency plan must be implemented varies greatly. It must first and foremost be operative and adapted to the specific case.

The contingency plan must always be posted in the immediate vicinity of the work area and be visible and known to everyone.

PERSONNEL HOISTS/TELESCOPIC LOADERS WITH BASKETS

The hoist must be suitable for the tasks to be performed. This includes load-bearing capacity, attachments, etc.

The work platform must display a clear sign which describes the maximum permitted load. The control panel must bear clear pictograms.

There must be instructions for use in Danish and other languages which the employees understand and which describe what the hoist may be used for, how it is operated, how it can be lowered in an emergency and also its daily maintenance. The same applies to verbal instruction and training.

For minor repair and maintenance work, it can be advantageous to use a telescopic loader or lift with basket. The machine and basket must be CE marked and type tested together. This approval will appear from the supplier's instructions for use.

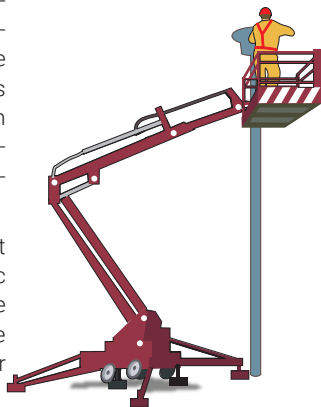

When working from baskets, you must:

- stay inside the basket while working,
- use fall prevention equipment consisting of a safety harness and short line of max. 50 cm attached to the basket.

Work from an open front basket may only be carried out if the basket and machine are CE marked and type tested for this type of work. The manufacturer's instructions for use must state how the machine is to be used - including whether it is permitted to work with an open front. It is not enough to ask the leaser.

3. CRANES, LADDERS AND SCAFFOLDING

Logs

The log should detail all events with regard to the equipment. Information on load tests, repairs and inspections must also be provided. The owner of the equipment is responsible for keeping the log.

Inspections

A main inspection must be carried out by the supplier or another expert at least once a year.

Design

The work position must have an enclosure 1.1 m high on all sides. This enclosure must either be made of a suitable panel material or be in the form of secure guard rails. Guard rails must as a minimum have a hand rail, a knee rail and a 0.15 m high foot rail with no gap from the floor.

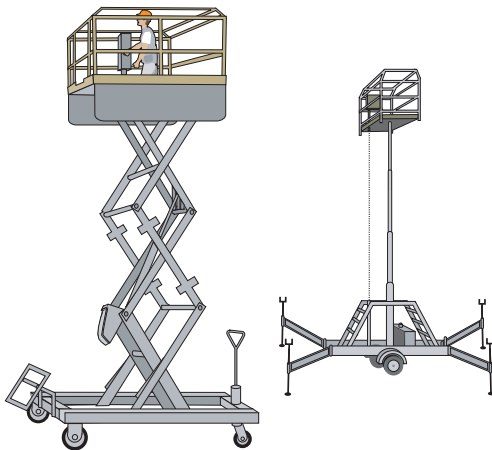

The gate in the basket must be self-closing and must not open outwards.

To avoid hands from being trapped, there should be a 10 cm hand rail within and 10 cm outside the edge of the basket.

The operating buttons in the basket must include an emergency stop button, clearly labelled to avoid incorrect operation. Buttons, handles, etc. for operation of the personnel lift must be marked with symbols which are easy to understand (pictograms) or text in Danish.

Use of personnel lift

People on the work platform must use safety harnesses and safety lines. However, this does not apply if the lift can only lift vertically, e.g. scissor lift.

The location must be secure and load-bearing. The manufacturer's information on the use of stabilisers and maximum gradient on the ground must always be followed.

If installation and use of the lift takes place on and near public roads, the work is covered by the road regulations. Where there is a risk of collision, appropriate measures must therefore be taken. Before work commences, a signage plan must be drawn up and approved by the road authority. If the signage plan entails a speed limitation, police approval is also required.

In addition to the person working in the lift, there must be at least one person in the immediate vicinity who can be called in the event of stop-pages or accidents when work is being carried out on the lift. It must be possible to call this person by shouting or mobile phone and the person must be trained in the emergency lowering procedure. "In the immediate vicinity" means that the person must be able to hear when shouted to from the basket.

Personnel who are to use the lifter must be properly trained and instructed in its use. Minors under 18 may only operate lifts in connection with industrial skills training, e.g. as apprentices.

However, minors under 18 may work from a personnel lift.

PERSONNEL LIFT WITH CRANE BASKET

As a general rule, lifting people in a crane basket is prohibited unless the crane is specially equipped to do so.

However, on the basis of an application, the Danish Working Environment Authority may grant a special dispensation. The following information must be forwarded beforehand:

- A risk assessment showing that other safer solutions cannot be used for technical or financial reasons, and that the safety of personnel lifts with cranes is sufficient.
- Time period for personnel lifts in crane and description of task.
- Drawings and calculations of the crane basket you plan to use.
- Documentation that the safety factors used in the dimensioning of cranes and lifting tackle comply with applicable requirements.
- Description of the inspection and control procedures that you intend to use before work begins - both after installation and on a daily basis.
- Identification of the crane to be used for the personnel lift and documentation of the crane's safety condition, including completed 12 month and 10 year inspections.

Use

The person in the basket and the crane driver must be able to talk to one another, possibly by means of a radio or telephone.

The work basket must not normally be left in its raised position. If this is necessary to allow a task to be done, an exemption must be applied for first.

An application for exemption is conditional upon:

- A description of the work
- Operatives should wear approved fall arrest equipment when leaving the basket and the fall line is always attached to the crane hook or fixed part of the construction

- Ensure that a check and maintenance procedure is in place for fall arrest equipment and securing of the line
- Ensure that the task is constantly monitored.

There is a long series of requirements with regard to the design of the crane and the basket. For more information on this, see the Working Environment Authority's guides.

LADDERS

When undertaking work at height, assess which technical equipment is the most suitable for the job to enable it to be carried out responsibly and with regard to health and safety.

Ladders are primarily used as short-term access routes from one level to another. However, in exceptional cases, ladders can be used to work from, e.g. due to lack of space, where other technical equipment cannot be used – and only when the work from the ladder can otherwise be carried out with due regard to health and safety. Smaller platform ladders, mini scaffolding, step stools, etc. are recommended for use in small and narrow rooms.

Ladders must be suitable for the tasks in hand. This applies to design and size, etc. With regard to the work in hand, there must be instructions for use in Danish and other languages that the employees understand and which describe what the ladder may be used for, correct set-up, daily maintenance, etc.



Ladders for normal use must comply with the provisions of EN 131. However, ladders can also have other equally as safe designs. It is also advisable to use ladders with wide steps for a better working position.

All ladders must be inspected at suitable intervals for slackness, splits and fractures. Defective ladders must be repaired or scrapped immediately.

3. CRANES, LADDERS AND SCAFFOLDING

Use

Ladders may only be used for work for short periods. The time limit for specific tasks is 30 minutes.

If work takes place alternately from ladders and firm surfaces, ladder work must not exceed 1/3 of the daily working hours.

If work is to be undertaken where both hands are to be used, step stools or platform ladders complying with the applicable DS/EN standards must be used, and the use of lifts or scaffolding is recommended when working above 2 m.

Other rules when working on ladders:

- When working on twin step ladders and single step ladders/extension ladders, the employee must not get closer to the top of the ladder than standing on the third top ladder rung.
- Wear appropriate footwear
- Only carry smaller objects with one hand
- Tools must be light and easy to handle
- It must be possible to operate tools with one hand. It must be possible to hold onto the ladder with one hand
- The working height should normally not be higher than 5 m (from the ground to the step you are standing on).

In exceptional cases, work may be performed higher, e.g. during element assembly, replacement of lamps and other service tasks. As work from traditional ladders in many cases involves an increased risk of accidents and wear and tear, the use of step stools, platform ladders, lifts or scaffolding is recommended.

For ladders higher than 5 m there must always be a person at the foot. When installing elements, ladders can be used for working heights up to 8 m in connection with:

- Mounting of top brackets and railing sceptors
- Attaching and unattaching elements
- Fitting of elements
- Sealing
- Minor repairs.

Ladders as access routes

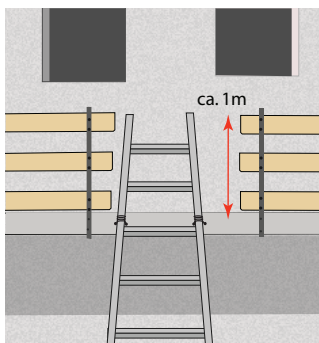

If you have to use a ladder as an access route, it has to be secured properly. It must also be at an appropriate gradient, and there must be a handhold approx. 1 m above the top level.

Working at height from rope

The employer must ensure that work at height is only performed from ropes when, after the work place assessment, work can be performed safely and when it is not appropriate to use other and safer work equipment with collective protection such as lifts, scaffolding or other technical equipment. For example, when working in hard-to-reach places, e.g. inspection under bridges.

3. CRANES, LADDERS AND SCAFFOLDING

The employer must ensure that there is a written contingency plan in place on how to deal with problems when working at heights from ropes and that there is an emergency response at the work site that can immediately intervene and carry out rescue at heights.

If prior assessment suggests that working at height from rope is the safest and most suitable solution, the following must be complied with:

- The employer must ensure that the work equipment and equipment for protection against falls made available to the employees for work at height from ropes is manufactured in accordance with the applicable DS/EN standards.
- The part of the equipment to protect against falling, which is the attachment point for the securing rope, the securing rope, harness and interconnecting devices, must be CE marked, cf. the rules on the fitting of fall arrest equipment. Only CE marked equipment can be used for that part of the equipment.
- At least 2 ropes must be used, each with its own independent anchor point – one being the work rope and the other the securing rope. Anchor points must be approved and fit for purpose and load. It may be necessary to carry out 'attachment tests'.
- The employee must be equipped with a climbing harness which must be connected to the securing rope.
- The work rope must be equipped with a safe climbing and lowering mechanism and have an automatic blocking system.
- The lanyard must be fitted with a moveable fall arrest device that follows the movements of the user.
- Tools and other accessories must be securely attached to the climbing harness or chair.

- Personnel performing work at height from ropes must have received special adequate training and instruction in the performance of the work in question, in particular in the relevant rescue procedures. Training and instruction of the employees can, for example, take place on courses in work from rope and at height, which are held – usually run by the AMU - by internationally recognised rope access organisations.
- The employer must ensure inspection of the equipment used for rope work and that the equipment is monitored and maintained systematically in accordance with the supplier's instructions.

LIFTING AND HOISTING EQUIPMENT

The equipment must be designed for the tasks to be performed. This applies, for example, to attachments, etc. The equipment must have instructions for use in Danish and any other languages understood by the employees. These must also indicate what the equipment may be used for, e.g. operation, maximum permissible load, usage restrictions and daily maintenance.

Minors under 18 may only operate hoisting equipment in connection with industrial skills training (e.g. as apprentices), and if they have received the proper instruction and hold the necessary certificates.

3. CRANES, LADDERS AND SCAFFOLDING

Training and certificate requirements

Certification is reward if you are to use lifting equipment - either free-hanging or supported to lift loads. See the table below:

Course name / no.	days	Notes
Crane base, supplemented with joint lifting with cranes Course no. 48586	10	The course is a basic crane course in which the participant learns to hook loads and move cranes and similar machines over 8 t/tm. The course provides the competence to drive overhead cranes. However, tower and fixed cranes and mobile cranes require special superstructure training in addition to the basic crane course. The basic crane course provides skills for joint lifting with cranes and hooking.
Tower crane and fixed cranes including the basic crane qualification Course no. 48684	22	For using tower cranes and fixed cranes with a lifting capacity > 8 tm. The training is a supplement to the basic crane course. The training requirements are all included in this 22 day course.
Mobile cranes > 8-30 tm Course no. 48643	5	Mobile cranes with lifting capacity > 8-30 tm require a supplementary course as part of the basic crane course. If you already have a basic crane qualification, you can supplement it with this five-day course.
Mobile cranes 8-30 tm including basic crane course Course no. 48644	10	Mobile cranes with lifting capacity > 8-30 tm require a supplementary course as part of the basic crane course. If you do not already have a Crane Base, the courses Crane Base and Mobile Cranes are offered as a total course lasting 10 days.

Course name / no.	days	Notes
<p>Mobile cranes > 30 tm</p> <p>Course no. 48646</p>	15	<p>Mobile cranes with lifting capacity > 30 tm require training: Basic crane course, mobile cranes > 8-30 tm and mobile cranes > 30 tm.</p> <p>This applies, for example, to crane lifts with construction machinery, lorry-mounted cranes, self-erecting tower cranes with a lifting capacity of > 30 tm.</p>
<p>Telescopic loader with forks and basket</p> <p>Course no. 48671 and 40073</p>	5	<p>Using a telescopic loader with forks and using a man basket requires telescopic loader training. The training corresponds to the previous telescopic loader A training.</p> <ul style="list-style-type: none"> • Old forklift certificate B no longer gives the right to drive a telescopic loader. • Forklift certificates issued after 1 January 2018 do not give the right to drive telescopic loaders.
<p>Basic crane course – Telex loader with crane lift above 8 tm</p> <p>Course no. 48678</p>	7	<p>If a telescopic loader is used for crane lifts with lifts > 8 tm, in addition to the telescopic loader training, the basic crane course must also be passed. These two training requirements are collected in this 7-day course.</p> <p>If you have already completed the basic crane course, you need only complete a telescopic loader course as a supplement to the basic crane course in order to operate a telescopic loader with a lift > 8 tm.</p> <p>To participate in the course, the participant must also have a certificate from course 48671 or 40073, each of which has a duration of 5 days.</p>
<p>Fork lift truck</p> <p>Course no. 47592</p>	7	<p>Forklift certificates give the right to drive forklifts and forklift stackers.</p> <p>Forklift certificates no longer give the right to drive a telescopic loader.</p>

3. CRANES, LADDERS AND SCAFFOLDING

<p>General requirements and exceptions</p>	<p>There is no requirement for a basic crane certificate with a permitted load of up to 8 t/tm.</p> <p>There is no requirement for a basic crane certificate for construction machinery, mini loaders and telescopic loaders used as cranes in connection with their normal tasks. However, this exception does not apply until all of the following conditions have been met:</p> <ul style="list-style-type: none">• If no other persons are in the immediate vicinity of the load being lifted, transported or unloaded. The load must be guided into place during unloading.• If the load is not lifted more than approx. 1 m above ground level.• If the machines are inspected and maintained in accordance with the supplier's instructions.• If the supplier's instructions for use and maintenance are on the machine. <p>The exceptions apply to all crane and certificate types, including telescopic loaders used for crane work.</p> <p>However, in this instance, the employer has a special responsibility to instruct and train his employees in the use of the machines - regardless of the use of the crane, the load and the size.</p> <p>In combination with the mentioned certificate types, driving licences for passenger cars and/or trucks are required to use the machines on public roads.</p>
---	--

It is not necessary for an employee to have a crane operator's licence if he or she is only occasionally required to operate construction machinery fitted with a crane in connection with the normal type of work the machine is used for. The operator can perform the work if the

following conditions are met:

- There must be no persons in the immediate vicinity of the load when it is lifted, transported and unloaded.
- The load must not be lifted more than approx. 1 m above ground level.
- The machines must be inspected and maintained in accordance with the supplier's instructions.
- The supplier's instructions for use and maintenance are on the machine.
- The machine is designed for crane work, cf. the supplier's instructions for use.

Inspections

The driver must report any fault or irregularity in the equipment to the employer. This is important so that the equipment can be fixed before work recommences.

At least once a year, the supplier or other qualified person must carry out a main inspection in accordance with the manufacturer's instructions. Hoisting gear used outdoors must also undergo a 10-year inspection by a special expert. The result of the 10-year inspection must be documented in a report, which the Danish Working Environment Authority must receive a copy of.

Logbook

Equipment which requires notification must have a logbook describe the history of the equipment and include information on load tests, repairs and inspection. The owner of the equipment keeps these logs.

Reporting

There are a number of hoisting implements which must be reported to the Working Environment Authority in connection with new purchases, change of owner or following significant renovation or repair.

3. CRANES, LADDERS AND SCAFFOLDING

This is applicable to:

- All hoisting gear and winches designed for lifting persons.
- All hoisting gear and winches used for changing installation positions.
- Permanently mounted lifting equipment with a maximum load of more than 300 kg. The limit is 1000 kg for electric hoists.

For every new installation, it is also necessary to report permanently mounted hoisting gear and hoisting gear requiring significant installation work. This is applicable e.g. in connection with moving tower and construction cranes, irrespective of whether the installation is taking place for the same owner.

Mobile hoisting gear, e.g. winches, mobile cranes and truck-mounted cranes, do not have to be reported when setting them up for the same owner.

Load testing

Load testing of all new hoisting gear must take place before it is commissioned. Also carry out load testing in the event of:

- Major reconstruction or repair
- Every main inspection and 10-year inspection
- Replacement of lifting attachments
- New installation where a report also has to be submitted to the Working Environment Authority.

CRANES

Minors under 18 may only operate cranes in connection with industrial skills training (e.g. as apprentices), and if they have received the proper instruction and hold the necessary certificates.

Wind

The maximum wind strength under which the crane may work must be described in the crane's usage instructions.

Even a light wind may cause the load to swing and can therefore make lifting unsafe.

In this specific situation, the crane operator must assess whether it is possible to carry out the operation safely so that it does not endanger the equipment, the rigger and others.

Rigging

When a load is attached to or released from a crane hook it is called rigging. The rigger must be specially employed, trained and instructed in carrying out the work - also for the specific rigging work. Training can be via participation on a specific rigger course offered by AMU schools and also at certain suppliers of rigging equipment. There is no requirement for the rigger to have completed a rigging course, but this can be an advantage.

The rigger must be familiar with the labelling of the rigging gear, which states the permitted load for chains, slings, etc., and the maximum sling angles.

A startup meeting should be held prior to installation work. At this, the rigger and crane operator review the order of installation and the guidelines for the individual lifts. Always follow the instructions for rigging on the load/delivery note. Be aware that when guiding is by using tag lines or similar, riggers must keep clear of the load until the load is on the ground, e.g. at the installation site and can no longer swing, etc.

3. CRANES, LADDERS AND SCAFFOLDING

Before the final lift, raise the load slowly clear of the ground and check:

- that there is equilibrium (the load hangs straight)
- that the slings and rigging gear are correctly positioned
- that the straps are not jammed (fishing)
- that the load does not get stuck to the surface.

When removing the load, the rigger must ensure:

- that the load can be removed safely, securely supported and in such a way that the rigging gear can be removed without risk
- that the rigging gear is kept tight during any bracing of the load.

The gear can be sent back once the load has been attached safely to the crane hook and secured to prevent movement.

If there is any doubt about the safety of the rig, the weight of the load or any other aspect, work must stop. This is the responsibility of the rigger, who must then consult the foreman/crane operator.

If lifting is already in progress, the operator must immediately lower the load to the nearest safe resting position.

The rigger and crane operator are entitled and obliged to refuse to do a lift if they feel that the lift may be dangerous.

Loads must not be transported by crane across work areas where people are working. The area must be cordoned off and the crane operator must ensure that the area is kept clear of personnel.

Signs to be used when rigging

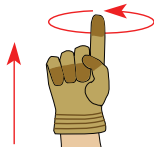

Hoist



Lower

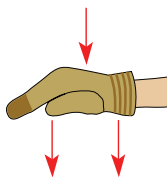

Lower (used at short distances between rigger and crane operator)



Rising barriers



Swing left

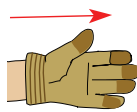

Swing right

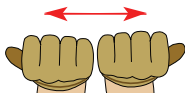

Telescope out

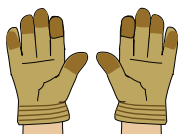

Quick stop

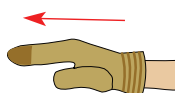

This direction

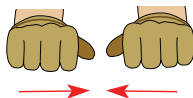

Telescope in

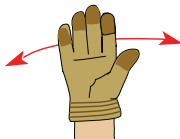

Signal not understood



For long distances use the "lollipop"

3. CRANES, LADDERS AND SCAFFOLDING

Rigging gear

All rigging gear must be CE marked.

All lifting connectors and other lifting gear must be clearly marked with SWL or WLL - which is an expression of maximum permissible load - as well as the date of the last inspection. The rigging gear may also be supplied with a colour code which indicates when the last inspection took place; cf. below.



The colour code white indicates that the material has been discarded

Rigging gear must be checked every time it is used, and it must undergo a main inspection at least once a year.

 Follow the supplier's instructions on when the gear should be replaced. The rigging gear should have instructions for use in Danish and any other relevant languages. There must be instructions for use in Danish and other languages which the employees understand and which describe how to use and check the rigging gear correctly, etc.

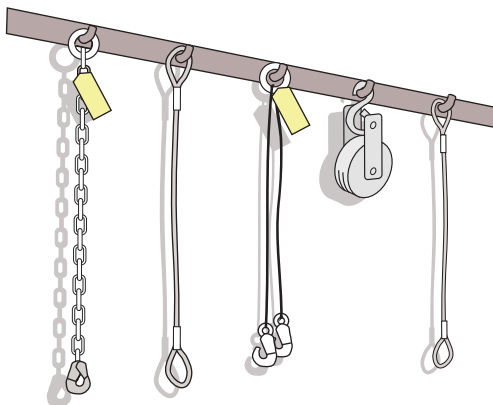

Rigging gear should always be stored properly in a dry, well-ventilated place. Fibre ropes in particular must be protected against direct sunlight as ultraviolet rays will break down the fibre. Disused gear must be kept separate from other gear.

- Crane and hoisting hooks must be provided with locking devices to prevent them becoming unhooked.
- Galvanised rigging gear must not be used for lifting tasks in salt water.
- Wire webbing must not kink when tensioned.
- Chains must not become twisted under loads. Shortening must take place using an approved shortening hook and joints must be made using approved joint links.
- Straps/fibre rope must be protected against sharp edges.

Double lifting

Double lifting with cranes must be planned carefully. This task must be managed by an expert, who must maintain safe communication with both crane drivers.

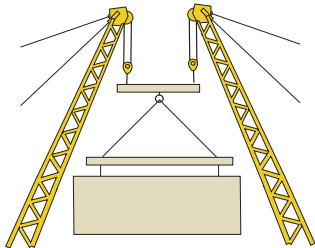

Both cranes should be of the same type, and ideally use the same speed regulation system. At no time may the load exceed 75% of the capacity of each individual crane. If necessary, special gear must be used which ensures correct weight distribution and vertical lifting.

TOWER CRANES

Erection

Only specially trained personnel may erect tower cranes. When erecting a crane, the supplier's instructions must be followed –

3. CRANES, LADDERS AND SCAFFOLDING

especially with regard to substrates, tolerances, securing of crane tracks, etc. After installation, the crane must be reported and tested.

The crane must be placed on a site that can bear weight and at a safe distance from embankments and excavations. Moving parts on the crane must not present a risk of crushing - the distance between crane parts and buildings, structures and materials must be at least 50 cm.

During installation, it is important:

- to set up signs showing permissible loads
- to check height stop, operation and end stop and emergency stop
- to check signalling devices (bell/horn)
- that the Operator's Manual and Journal are present in the cab,
- to test drive the crane with the crane operator so that any problems can be rectified before the service technician leaves the site

There must be a personnel lift on the crane when the cab access route is higher than 25 m. However, this only applies if the crane is to stand for more than two months and if this is practical and technically possible.

There must be warning signs stating: "Gå ikke under hængende last." [Do not walk beneath suspended loads.] when the crane is used in areas where people are moving around. Signs must be clearly legible and visible.

Crane rails

Requirements for crane rails:

- The crane track must be placed on a solid base. Materials which may become wet and thereby impair the stability of the crane must be dug out and replaced with another load-bearing material (such as broken stone ballast, laid out in thin layers and rolled after each application).
- If necessary, the crane track can be secured by casting the sleepers in concrete.
- Drain the crane track and align the rails so that they comply with the tolerance for distance and height difference.

- Rail joints should be made to ensure a rigid joint of the rail ends. These are supported by double or particularly wide transverse sleepers.
- The track must be laid so that there is a safe distance from the track to embankments, excavations, fixed elements and material storage.

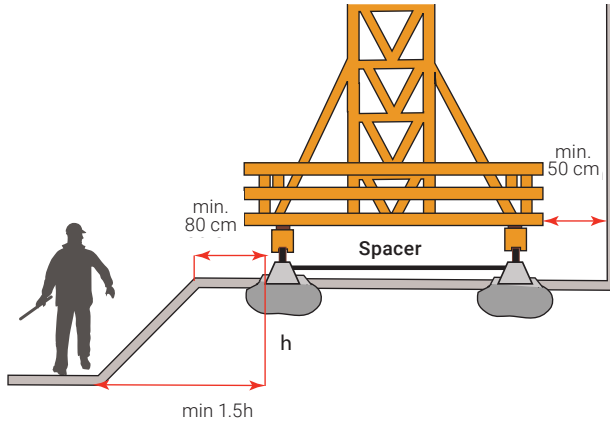

Once the track has been laid, check:

- that the track width is correct and that the dimensions and tolerances specified by the supplier are complied with - and that there is a smooth transition to curve operation
- that the track is fitted with fixed end stops on each rail and suitably far from the outermost rail support, but at least 30 cm. that the end stops are positioned so that the stops in the same tracking ends are touched simultaneously by the crane
- that the operational end stop of the driving machinery is positioned so that the crane is fully braked before the fixed end stops are reached
- bogies (running wheels) are straight on the rails and have rail currents, deflector shackles and rail claws fitted
- that the crane is equipped with devices so that it cannot tip over in the event of shaft failure or derailment.

3. CRANES, LADDERS AND SCAFFOLDING

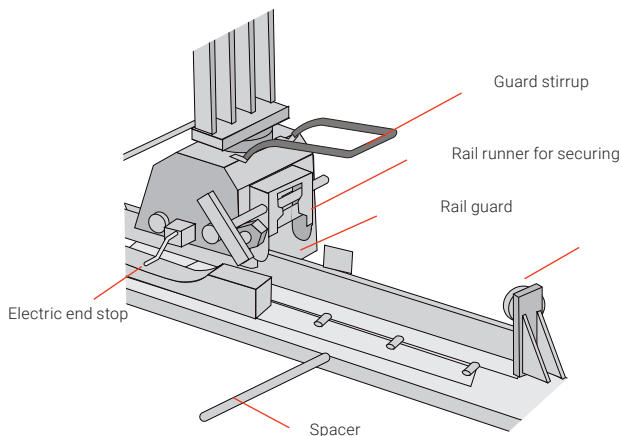

A crane moving on rails must not be able to collide with personnel, e.g. in situations in which a full overview of the driving area is not possible. This can be rectified by cordoning off the operating area or by providing the crane with flexible contact stops. Crane rails should be checked by driving through the curves before the fitters leave the site.

Collision

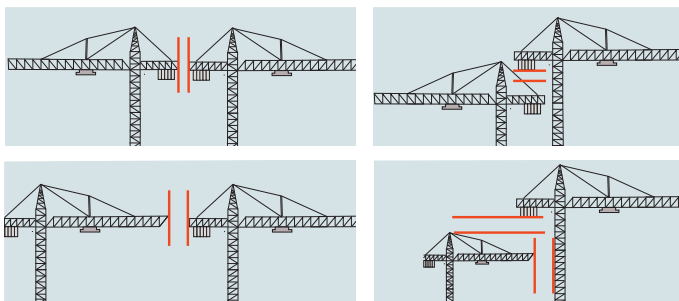

If several tower cranes are in the same position, they must not be able to collide with each other. When parking, the jib must be able to yaw freely in the wind without risking colliding with other cranes or building elements.

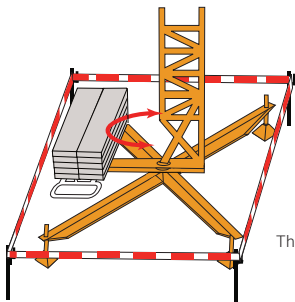

The yaw area must be marked with a clear and durable marking.

MOBILE CRANES AND OTHER MOVING CRANES

The risk of tipping over is dependent on the load-bearing capacity of the substrate on which the crane is standing. Before lifting anything, therefore, the load-bearing capacity of the substrate must be documented. Supporting legs must be used as described in the crane's usage instructions, and the maximum supporting leg pressure will also be specified here.

Supporting legs must be folded out (extended) so that they correspond to the load and jib radius in question.

All supporting legs must be placed on a load-bearing substrate – where necessary, use plates beneath supporting legs to distribute the load over the substrate.

If the crane is to operate with a lifted load, the surface must be level and firm - corresponding to a road completed for surface treatment (asphalting). Otherwise, transport plates must be laid out.

Loads must not be transported by crane across work areas where people are working. The area must be cordoned off and the crane operator must ensure that the area is kept clear of people.

LIFTING WITH FORK LIFTS

Pallet forks must only be used to lift loads which are suitable for lifting with a fork lift. It is necessary to make the load safe by securing it or by tilting the forks backwards when moving with the load. The forks must not be used directly as crane hooks.

The forks must be inspected regularly for wear, cracks and deformations. Forks may only be repaired by specialists, and only according to the supplier's instructions.

Minors under 18 may only operate machinery with forks for lifting if this takes place in connection with industrial skills training, e.g. as apprentices, and only if they have received proper instruction and hold the necessary certificates (see more in the section on certificates).

LOADING AND TRANSPORTING MACHINES

Backhoe loaders, caterpillar tractors with shovels or blades, rubber wheel loaders, dumpers, scrapers, graders, etc. are considered loading and transport equipment.

The following must be ensured for these machines:

- Inspection in accordance with the supplier's instructions, but at least once every 12 months
- The machine must always be accompanied by a Danish user manual and, if necessary, in another language understood by the driver
- The vehicle must have a roll-over protective cab.

Only people aged over 18 and who hold valid driving licences – or tractor licences, as a minimum – may drive loading and transport machinery. Minors under 18 may only operate loading and transport machines in connection with industrial skills training, e.g. as apprentices, and only if they have received proper instruction.

Separate vehicle and pedestrian traffic whenever possible. Personnel must not be in the vicinity of working machines where there may be a risk of being hit by the machine.

Use a positive pressure cabinet when working in contaminated soil and in a dusty environment.



CONSTRUCTION SITE LIFTS, TRANSPORT PLATFORMS AND MATERIAL HOISTS

It is recommended to establish lifts, transport platforms and material hoists wherever possible when working at height or in deep excavations.

At minimum, lifts/transport platforms must be established for locations where work takes place for more than two months at a height of more than 25 m above ground level or more than 25 m in depth.

It is recommended that lifts are also installed at lower heights or at depths to transport personnel and materials.

Only specially trained personnel are allowed to install, dismantle and modify construction site hoists, transport platforms (building hoists for transporting people and materials) and material hoists (vertical and inclined). Installation must be in accordance with the manufacturer's instructions.

Minors under the age of 18 may only operate construction site lifts/transport platforms that are not push-button controlled if this takes place in connection with industrial skills training, e.g. as apprentices, and only if they have received proper instruction.

The owner of the lift or the person leasing the lift must ensure that the lift and its accessories are properly maintained in accordance with the applicable requirements.

3. CRANES, LADDERS AND SCAFFOLDING

Construction site lifts and transport platforms

The main difference between building site lifts and transport platforms (building hoists for transporting people and materials) is that the chair on a building site lift is closed whereas it is open on a transport platform. A Roof (partial roof) is required if the transport platform is installed in a place where there may be a risk of something falling from height, e.g. where there is scaffolding.

In addition, the same requirements apply to installation control, inspection, etc.

Erection inspection

In the event of new installations, relocation or significant repairs, erection checks must be carried out on the construction site lift/transport platform. Only an inspection body accredited by a recognised accreditation body may carry out the installation inspection.

The building site lift/transport platform may only be used once it has been set up correctly without errors or defects. If the construction site lift/transport platform can be used, this will be noted in the service book and an inspection sign will be posted in the hoist with the date of the next inspection time and testing.

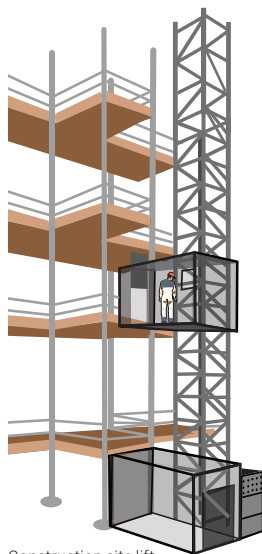

Construction site lift

Inspections

Only an expert company certified for this purpose (not an inspection body) may carry out inspection, maintenance and repair of building hoists/transport platforms.

The construction site lift/transport platforms must be inspected at least once a month.

The number of inspections per year must be stated in the construction site lift's service book.

Copies of inspection reports must be provided the service book. Inspections also include access routes to the construction site elevator and charging points.

Inspection and testing

If the lift/transport platform is installed more than 12 months in the same location, it must be inspected and tested every calendar year at intervals not exceeding 14 months. The same requirements as for erection inspection apply during inspection and testing.

Requirements for use

Construction site elevators/transport platforms must be provided with a sign stating their use - including inspection signs and maximum persons/load.

Construction site elevators/transport platforms must be secured so that only the door/gate at the landing point can be opened. The manufacturer's door system must be installed at the loading site at ground level, on the scaffolding or on the building. When the gate system is open, the lift/transport platform must not be able to operate. Similarly, the machine's other safety precautions must be installed, including fencing at ground level.

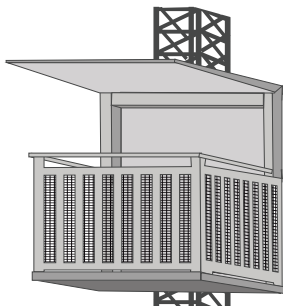

Transport platform

Requirements for the use of construction site lifts/transport platforms must comply with the guidelines in DS/EN 12159 (personnel lifts) and DS/EN 16719: 2018 (transport platforms) respectively.

3. CRANES, LADDERS AND SCAFFOLDING

In principle, the floor of construction site lifts/transport platforms must be level with the surrounding terrain so that materials and people can move freely from ground to hoist or vice versa.

Material hoist

Inspections

An expert must ensure, through appropriate inspection and maintenance, that the material hoist is in good condition at all times.

The expert must undertake the inspection prior to commissioning and after every setup. If the material hoist has been installed for a longer period of time in the same location, it must be regularly inspected in accordance with the supplier's instructions – however, a main inspection must be carried out at least every 10 months by the supplier or other expert.

It must be possible to document the results of the inspection and to make them available to the Working Environment Authority.

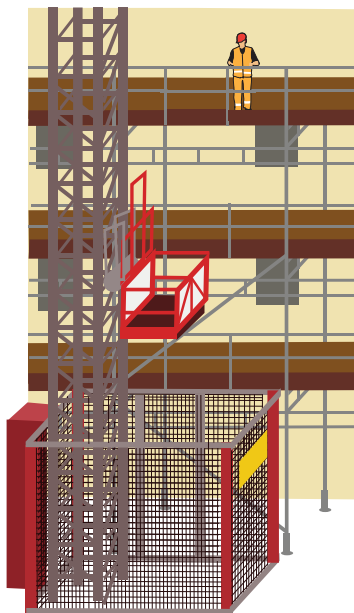

Material hoist

Requirements for use

The material hoist must be equipped with a sign stating the use of this - including inspection sign and maximum load.

The material hoist must be secured against the risk of falls from the chair and loading area. This means that all loading areas above ground level must be fitted with full guard rails.

The material hoist must be secured so that only the door/gate at the loading point can be opened. The manufacturer's door system must be installed at the loading point on the scaffolding or building. When the gate system is open, the material hoist must not be able to operate. Similarly, the machine's other safety precautions must be installed, including fencing at ground level.

The chair on the material hoist must be secured with railings at a height of 1 m.

The material hoist must be set up so that there is no crush hazard when working or moving around in the immediate vicinity of the hoist, e.g. on scaffolding.

The layout must follow the guidelines in DS/EN 12158-1 (goods lifts).

As a starting point, the floor of the material hoist must be level with the surrounding ground so that materials can be transported freely from hoist to ground or vice versa.

Inclined hoists

Inclined hoists must be set up in accordance with the manufacturer's instructions. The material hoist must be marked with the maximum permitted load.

The following rules also apply:

- Rails must be securely fastened to both the ground and roof edge.
- Any stabilisers must stand on firm and stable ground and be secured against skidding.
- The area around the hoist must be cordoned off to unauthorised traffic.
- There must be an emergency stop from the operating site and there must be an overview of the movements of the floor.
- The load must be secured against falling off and must not protrude more than 20% over the side edge of the bed.

3. CRANES, LADDERS AND SCAFFOLDING

- Guard rails must be used to secure stands at the roof edge or wall openings against falling.
- It must be possible to disconnect the hoist at a lockable main switch.

Minors under 18 may only operate the material hoist in connection with industrial skills training, e.g. as apprentices, and only if they have received proper instruction.



MACHINERY AND TOOLS, GENERAL

General information about machine safety

The EU Machinery Directive was introduced into Danish legislation in 1993 and primarily contains requirements for manufacturers on how to design machines. The Machinery Directive's requirements for safety and marketing are applicable to all machines produced after that date. The Directive is also applicable to all used machines imported from countries outside the EU.

Machinery produced before 1 January 1993 must still be compliant with Danish regulations.

Purchasing machinery

Before buying a new machine, it is necessary to assess:

- Where and how it will be used.
- Who needs it. What are the possible health and safety risks?
- How does the machine compare to similar machines?
- What is the daily cleaning and maintenance like?
- Is the noise and vibration level acceptable?

When buying a new machine, a user manual in Danish must always be included, even if the group language is English, for example. The instructions for use must contain information on how to set up, use and maintain the machine.

Obligations of the supplier

On delivery, machines must be fitted with the necessary protective equipment. They must also be designed to be as user-friendly as possible and be low-noise and low-vibration.

There must also be warnings and information about other types of hazards that may arise in spite of the protective measures.



All new machines must be provided with a rating plate stating the manufacturer's name and address, series and type determination, serial number and year of manufacture, if applicable. The machines must also be provided with a CE label which indicates that the machine is compliant with the requirements of the Machinery Directive and hence Danish legislation. This label must be clear and durable.

When the machine is CE marked, the manufacturer must also provide an EU declaration of conformity with each machine.

The name and address of the importer must be stated on the machine.

Usage instructions

When preparing for work, there must be instructions for use in Danish and other languages that the employees understand, describing how to set up, operate and maintain the machine, hand tools, etc.

The instructions for use must also include information on how to:

- start the machine.
- use the machine.
- handle the machine.
- set up the machine.
- install the machine.
- adjust the machine.
- maintain and repair the machine.
- dismantle the machine for scrapping.

Any safety inspection requirements must also be specified in the instructions for use. They must also include information on the necessary training and any use of personal protective equipment, as well as information on vibration and noise levels.

These instructions include the plans and diagrams necessary for the use of the machine, maintenance, inspection, checking and repair, and other useful information, in particular with regard to safety. The usage instructions must be readily accessible.

Wherever possible, the instructions for use should be indicated directly on the machine.

User's obligations

Machinery etc., must always meet the requirements for technical equipment. It is up to employers, business managers, supervisors, repairers and other employees to ensure this. This is independent of the manufacturer and the supplier's obligations. Users must also ensure that machines and technical equipment are used appropriately in a safe and responsible manner with regard to health and safety.

Protective equipment or safety elements must not be removed when you use the machine. Employees must immediately reports faults with the machine or its protective equipment to the person responsible.

Gloves should in general not be worn when working with rotating machines and tools unless the tool is completely shielded from contact.

There are special regulations for children and minors. Unless part of a skills training programme, minors under the age of 18 must not normally operate machinery with high-speed cutting tools, such as circular saws, metal saws, cutting and cutting machines, cutting machines, milling and planing machines, etc.

Machines must also be shielded in such a way that the moving and machining parts are inaccessible during operation and there are no other hazards associated with the machine. The young person must be thoroughly instructed and trained in the use and be closely supervised by an experienced person, e.g. the apprentice.

Approval

There are no general requirements for machines to be approved, as it is the manufacturer who CE marks the machine and therefore guarantees that the machine and tools comply with applicable EU legislation (directives). However, a number of dangerous machines require type testing and type approval before the machine is CE marked.

If you are in doubt as to whether a machine complies with the applicable rules, you should request information from the Danish Safety Technology Authority. If you are in doubt about the rules for the use of a machine, contact the Danish Working Environment Authority's Call Center.

Validity

The rules for machine safety apply to all machines, irrespective of where they are to be used and by whom. These rules are also applicable to machines which are used entirely for private purposes (e.g. hobby machines).

Inspection of machinery

It is the employer's (user's) duty to regularly inspect machines and machinery in accordance with the manufacturer's instructions to ensure that they are fully safe.

The usage instructions must specify when and how regular maintenance is to take place. Always follow the supplier's instructions unless there are special Danish rules, e.g. for cranes and personal machines.

Inspection should take place at intervals set for each individual machine, e.g. in relation to how often it is used.

The supplier or another expert must carry out the inspection.

Setting up machinery

Machines must be set up such that it is possible to work with them comfortably and without risk. There must also be sufficient space to repair and maintain the machines.

Design of machines

Machines must be designed so that they do not pose a risk to safety or health when they are installed and maintained and when they are used for the purpose for which they have been intended.

In other words, they must be designed so that the following elements cannot cause injury:

- Moving machine parts
- Machine parts or materials being thrown out
- Development of e.g. smoke, gas, dust, hazardous substances and materials
- Noise
- Vibration
- Electricity
- Heat
- Cold
- Radiation
- Fire
- Explosion.

It must not be possible to reach or fall into the hazardous area.

You must be able to carry out your work at or with the machine in suitable working positions.

Protection devices and shields

Machinery must be used in accordance with the applicable regulations, taking into account the manufacturer's instructions. Protection devices and shields must therefore be set up and used as intended.

It must not be possible to disable or remove/disassemble protective devices and shields.

Protection devices must be inspected regularly, and their function and condition must be checked as indicated by the supplier.

Shields

Shields must prevent people from touching hazardous machine elements or tools, or such things from being flung out and causing accidents.

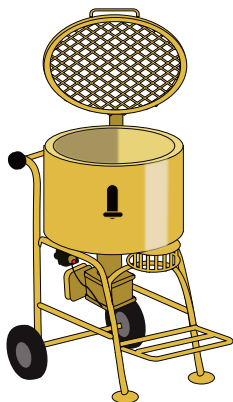

Shields are also used against the risk of radiation, e.g. in the case of heat, light, radioactivity and lasers, and against cold and draughts.

Operating buttons and handles

Buttons, handles and pedals for operation of machines must be designed and positioned so as to prevent incorrect operation. They must be designed correctly from an ergonomic standpoint.

Start buttons must be recessed, covered or subject to requirements, so that the machine cannot be started accidentally.

Operating positions

From the operating position, there must normally be a complete overview of the machine's hazardous zones. If this is not possible (e.g. in the case of larger, combination machinery), the starting device must automatically give a clear warning signal in plenty of time before the machine starts.

Stop device

Every machine must be fitted with a stop device which can be operated quickly, easily and without risk from a normal operating position.

Emergency stop

There must be an emergency stop on a machine if the emergency stop can limit accidents or stop near-accidents. In addition to the normal stop device, there must be an emergency stop at all operating points and the hazardous places on the machine. If necessary, the emergency stop must be combined with an automatic brake.

In some situations, emergency stops may also be integrated into operating pedals, pedals for operation of thread cutting machines and plate rolls. A gentle pressure on the pedal operates the machine, but if the pedal is fully depressed, it stops. This is a built-in emergency stop.

Restarting the machine normally can only be done once the emergency stop has been manually set back to "ready position" and the start button has been pressed.

If failure of the general controls may result in danger, there must also be an emergency stop together with the controls.

Remote control

Radio and other wireless controls are usually used in connection with the operation of cranes, lifting platforms, winches, stationary and mobile machines and gates.

It must be possible to carry the operating unit in such a way that it cannot be dropped. All hazardous machine movements must normally be controlled by using the hold-down safety function (dead man's control).

4. MACHINERY AND TOOLS

The box must normally be equipped with an emergency stop, a locking option, indicator lamp and durable and easily understandable operating symbols or text. The driver must normally be able to give a warning signal, e.g. a horn signal. The receiver must be protected against signals from external transmitters.

If a signal is interrupted, suffers interference or is not received, this must normally result in all movements stopping and braking.

When using remote-controlled equipment, signs must be posted in appropriate places to warn that remote-controlled equipment is being used.

It must be possible to interrupt the supply of energy to a machine quickly and safely and to safeguard against reconnection.

Hold-down button (dead man's control)

A hold-down button is a starter device which ensures that a machine can run only as long as the switch is held down. Anyone operating a hold-down switch must have a complete overview of hazardous machine movements. If the operating device is released, the operator must not be able to reach into the hazard zone until the hazard has been prevented, e.g. when the movement has stopped.

In special cases it is a requirement that the movement of the machine is stopped both when releasing the operating device and when using force to operate it, i.e. depressing it fully. A three-position switch (panic switch) can be used in these instances.

Two-handed operation

Two-handed operation prevents the operator inserting a hand into the hazardous area of a machine.

Two-handed operation must be positioned and designed so that:

- it is only possible to start the machine moving if you use both hands at the same time (normally the time must be less than 0.5 seconds)

- the machine movement stops in less time than it takes to move a hand from the two-hand control to the hazardous area, simply by releasing one of the controls
- that you cannot start a new machine movement until both controls have returned to their initial position
- Accidental and incorrect impact is prevented.

Note that there are a number of hazardous hand-held machines that can be operated with one hand, although the manufacturer states that the machine must be held with two hands. This means that normally the machine must be held with two hands and may only be deviated from if it is completely safe in terms of health and safety.

Brakes

A machine must be equipped with a brake if it continues after the motor has been switched off (run-on), and there is a risk of accidents.

The brake must operate automatically when the drive is disengaged. If it does not, it must be possible to operate the brake from the operating position. There must be a sign on the machine with durable and clear text about the function and operation of the brake.

MACHINERY FOR CONCRETE AND MORTAR

Mixing machines

Use a conveyor, screw conveyor, hoisting gear rather than shovelling if the mixing machine is used a lot. This helps to reduce the workload on those who need to load the machine.



Minors under 18 may operate mixing machines, transport conveyors, etc., if the machines are shielded in such a way that the moving and machine parts are inaccessible during operation and there are no other hazards associated with the machine. However, this only applies if the minor has been thoroughly trained and instructed in its use.

In connection with the work, there must be usage instructions in Danish and other languages which the employees understand and which describe how to set up, operate and maintain the machine.

Concrete surface finishers

Machines with petrol engines may only be used indoors when the rooms are well ventilated.



Surface finishers with rotating discs or propellers must be made safe as follows:

- Rotating discs or propellers must be shielded so that no part of a foot can reach into the danger zone
- The machine must have a hold-down button (dead man's control function)
- With a petrol-driven machine, it must be possible to activate the starter while holding the handle on the steering bar

Vibrators

Vibrators which are used to distribute wet concrete in moulds and to level off floors and floor decks are driven by low-voltage motors via transformers.

It may be necessary to restrict work periods if the vibration level is high (find out more in the section on vibrations).

Good maintenance is a must if vibration damping is to work effectively. There should be a switch on the operating handle if the vibrator motor is built into the unit.

Do not leave an immersion vibrator with the motor on.

If the vibrator does not have a switch in the handle, you have to take it to the switch, place it in a stand or secure it in some other way until it has stopped.

Minors under 18 may only operate concrete surface finishers and vibrators in connection with industrial skills training which (e.g. as apprentices), and if they have received the proper instruction.

MACHINERY FOR WOOD

Stationary machines

Table saws, bandsaws and planing machines must be set at a good working height. This will prevent people having to bend forwards unnecessarily. There must be a rolling trestle to support long or wide pieces.

Materials and finished items must also be placed at a good working height and as close to the machine as possible.

If handheld machines are used on benches as stationary machines, the requirements for stationary machines must be met.

There must be equipment that can trap or absorb dust and shavings at the cutting edge. This equipment must be specially adapted to the individual machines. Extracted air must not be recirculated. Woodworking

4. MACHINERY AND TOOLS

machines require the user to have received special instruction on how to use these machines properly. If necessary, use the test and instructions on www.maskinkoerekort.dk in connection with this instruction.

If you use materials and work processes that produce dust, you should try to remove or limit the dust at its source. This can, for example, be done in the following way:

- Use process suction connected to a suitable CE-marked vacuum cleaner, class H, if there are carcinogens in the dust that are present in most construction site dust. Remember that this must be a dust extractor.
- Use air purifiers to limit the amount of dust as much as possible. Continuous cleaning of surfaces - either by vacuuming or wet scraping/sweeping. Work from top to bottom as far as possible to avoid dust contamination of finished areas.
- Use working methods where the employees are separated from dust generation, e.g. by using construction machines equipped with an overpressure compartments. Dusty work must be carried out in an area separated from other employees.

In general, gloves must not be worn when working with woodworking machines unless the tools are entirely shielded to prevent contact.

Machines with fast-moving cutting tools such as circular saws, table saws, crosscut saws, and planing machines may be operated by minors under 18 if the machines are shielded in such a way as to render the moving and machining parts inaccessible during operation and there are no other hazards associated with the machine. However, this is only possible if the minors receive thorough instruction on how to use the machine.

In connection with the work there must be instructions for use in Danish which demonstrate how to set up, operate and maintain the machine.

Circular saws (stationary)

The blade must be flat and without wobble, "blue spots" and cracks.

- The blade must always be sharp and correctly fitted, and it must be not be missing any teeth.
- The part of the blade which is not in the wood must be shielded.
- It must not be possible to press the blade cover onto the blade.

Blades with carbide tips must be:

- intact, i.e. without missing teeth.
- fitted with a riving knife.
- fitted with a voltage drop relay.

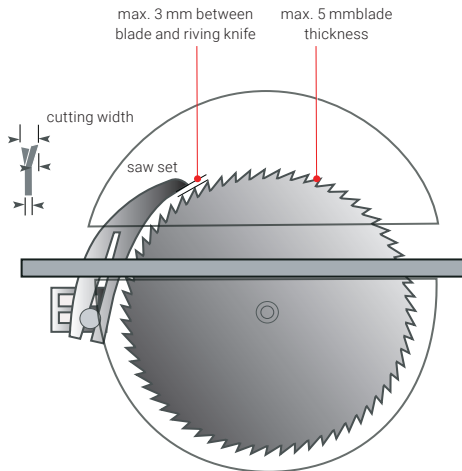

The riving knife prevents the wood pinching the blade, lifting it and throwing it back at the user. It also shields the rear teeth of the blade so that loose pieces of wood are not thrown out. The riving knife must be rigid, thicker than the blade and thinner than the saw teeth. With carbide blades, it must be 0.3 mm thinner than the cutting width). The riving knife must be easy to adjust.

Table saws

When rip-cutting, the fence (width-controlled) must be used and set so that the wood can be moved along in a straight line.

Upper guard, lower guard and riving knife must be in position and adjusted. In the case of concealed cuts, e.g. groove and rabbet work, it is possible to remove the top guard as the wood covers the teeth of the blade. If the top guard is removed, a feed block must be used. When work is finished, the top guard must be immediately replaced. Use a pushing rod or handle if there is a risk of touching the blade during rip-cutting.

When cutting wedges, use a jig and attach a deflector strip so that the smaller cut wood pieces do not come into contact with the back teeth of the blade.

During shortening (crosscutting), it must be possible to control the wood by running it against an adjustable fence.

Crosscut saws (pendulum crosscut saws)



Crosscut saws with the blade beneath the bench must:

- be shielded beneath the bench
- be fully shielded when at rest
- be returned to their rest position automatically (balance saws)
- not be able to be pulled over the edge of the bench
- have a top guard or some other form of protection from the blade over the bench during sawing.



Crosscut saws with the blade above the bench must:

- have a guard around the blade as far down below the centre as possible

- have visor protection for the rest of the blade that is working. This part of the shielding must automatically be locked when the saw is at rest
- must return to resting position automatically
- must not be able to be pulled over the edge of the bench.

MACHINERY FOR METAL

Metal circular saws

In addition the instructions for wood chop saws chop saws or metal must also:

- be operated with a hold-down button (dead man's control)
- have an emergency stop
- stop as soon as possible when you release the hold-down button
- have a friction clutch or other means of preventing hazards caused by the blade cutting into the work or jamming.

Chop saws where the blade is fed mechanically must have additional protection, e.g. shielding, so that you cannot touch the tool, two-handed operation, photo-electric guard or similar.

Metal saws may be operated by minors under 18 if the machines are shielded in such a way as to render the moving and machining parts inaccessible during operation and there are no other hazards associated with the machine. However, this only applies if the young person has been thoroughly trained and instructed in its use.

In connection with the work there must be instructions for use in Danish which demonstrate how to set up, operate and maintain the machine.

Thread cutting machines

Thread cutting machines must be operated by means of a pedal or hold-down handle which stops the machine when it is released. The pedal must be shielded so that it is not possible to start the machine

4. MACHINERY AND TOOLS

accidentally, and it must otherwise be designed with three positions:

- Top position, no actuation: the machine is stopped.
- Middle position: the machine is running.
- Bottom position: emergency stop function.

Long, rotating pipe sections which protrude must be shielded and supported in pipe trestles.

Trimming of pipes which are rotating in cutting machines may only be done on machines with a pipe cutter fitted. Thread cutting and trimming must not be undertaken on pipes which have fittings installed.

Fittings must not be screwed onto pipes which are rotating in thread cutting machines.

Thread cutting machines may be operated by minors under 18 if they are shielded in such a way as to render the moving and machining parts inaccessible during operation and there are no other hazards associated with the machine. However, this only applies if the young person has been thoroughly trained and instructed in its use.

There must also be instructions for use in Danish which demonstrate how to set up, operate and maintain the machine.

MOTORISED HAND TOOLS

When buying hand tools:

- Choose a tool that dampens vibrations
- Choose tools that insulate against cold and have anti-vibration handles
- Choose silent tools
- Choose tools that are lightweight and easy to use
- Choose tools offering the option of connection to a dust extractor
- Choose tools with ergonomic handgrips – with enough room for your hands and of suitable with a good and secure grip

A high level of vibration (see the section on vibration) may restrict the amount of time in which the machine can be used every day.

The motor must be switched off and any plug or air connection disconnected when cleaning, adjusting or changing tools.

Minors under 18 must in principle not operate vibrating hand tools and similar with a level in excess of 130 dB(HA) unless in connection with industrial skills training (e.g. as apprentices), and unless they receive the proper instruction.

However, minors are allowed to carry out short-term work with vibrating tools (of less than 30 minutes' duration over the course of a full working day).

There must be instructions or use in Danish that demonstrate how to set up, operate and maintain the machine.

Chainsaws

Only power chainsaws which are type-approved or CE-labelled may be used. Power chainsaws must be maintained carefully, with frequent chain lubrication, chain tension checking, etc. When the chain is sharpened, it must be checked using a measuring tool.

The chain brake must be kept clean, and it is necessary to check that it works. The idle speed of the motor must be set so that it is considerably lower than the speed of the chain clutch.

The user must have a good knowledge of how the power chainsaw is designed, how it works and must be maintained, as well as being familiar with the safety requirements.

People with no experience of chainsaws must be trained by a person with a good technical knowledge before they are permitted to work independently with power chainsaws.

Do not work with power chainsaws from ladders, unless the ladder has a specially designed work platform.

4. MACHINERY AND TOOLS

- Only use specially designed motor-powered chainsaws (pole chain-saws) above shoulder height.
- Only use motor powered chainsaws indoors if there is effective ventilation due to the exhaust gas given off.
- Only use electric power chainsaws for voltages over 50 volts outdoors in dry weather.

The following personal protective equipment must be used when working with motor-powered chainsaws:

- Safety Helmet
- Eye protection, goggles or visor
- Leg protection, trousers with cut-resistant insert on the front of the leg
- Foot protection, safety boots with cut-resistant inserts
- Ear defenders, as the noise load exceeds 85 dB (A).

Minors under 18 must not operate motor-powered chainsaws unless this in connection with industrial skills training (e.g. as apprentices) and they receive the proper instruction.

There must be instructions for use in Danish and other languages that employees may understand that demonstrate how to set up, operate and maintain the motor-powered chainsaw.

ELECTRIC HAND TOOLS

Inspections

Employers must ensure that electrically operated hand tools are inspected regularly, normally once a year, depending on their use.

Based on the application, carry out a risk assessment of whether more frequent inspections are needed (how and how often the specific power tool is used).

Use

Minors under 18 must in principle not operate vibrating hand tools and similar with a level in excess of 130 dB(HA) unless this is in connection with industrial skills training (e.g. as apprentices), and unless they receive the proper instruction.

However, minors are allowed to carry out short-term work with vibrating tools (of less than 30 minutes' duration over the course of a full working day).

There must also be instructions for use in Danish and other languages, which the employees understand, describing how to set up, operate and maintain the hand tools.

Drills

Be prepared for the drill to get stuck.

Do not use the lock button.

Do not drill in loose objects (the work should be held in a vice or bench).

Use extraction fans – directly mounted on the machine.

Always wear suitable respiratory protection if dust and other pollution cannot be effectively removed.

Groove cutters



Dust which is harmful to health is given off when cutting grooves in masonry. Therefore, an extraction fan must be fitted to the groove cutter.

You must wear a dust mask while working, unless the dust can be removed effectively from your immediate area. You must also wear ear defenders.

Polishers

The following applies to belt grinders, vibrating sanding machines and eccentric grinders:

- Use extraction fans
- Always wear a dust mask filter unless dust contamination can be removed effectively.

Polishers often have very high levels of vibration.

Angle grinders

The most serious risk with grinding and cutting machines is disc shatter, as this can result in serious personal injury.



Disc shatter is caused by:

- the disc being tensioned incorrectly. Use correct tensioning flanges, shims and tensioning
- that the rotational speed is greater than that for which the disc is approved
- that the disc is used incorrectly and that there is, for example, uneven and/or excessive pressure
- poor levelling
- lazy handling with shocks and blows.

Safety rules when using an angle grinder:

- An angle grinder is always two-handed unless otherwise specified by the supplier in the user manual.
- Remove the plug from the socket when replacing the disc.
- Use a washer suitable for the machine and approved for the motor speed.
- Secure the washer with the correct tension flanges.
- Before use, check that the blade rotates without wobbling.
- The prescribed screen must be attached.
- Do not press hard on the blade.
- Do not subject the disc to uneven pressure or anything that could break it.
- Do not use cutting discs to grind or grinding discs to cut.
- Compressed air angle grinders must be secured against excessive speed caused by being connected to too high pressure.
- Always wear ear protection.
- Always wear eye protection, glasses with side shields or tight-fitting glasses.
- When hand grinders produce dust in hazardous quantities, they must have some form of dust extractor.
- Remove loose scarves, etc.
- Lay the machine carefully so that the blade does not get knocked.
- Lay the machine so that the blade does not get wet.

Jigsaws

When using jigsaws, there is always a risk of cuts, so pay particular attention when starting and finishing the job.

- Always wear ear protection.
- Always wear eye protection, glasses with side shields or tight-fitting glasses.
- When replacing blades - pull the plug out of the socket.

Handheld circular saws



Handheld circular saws should generally be equipped with riving knife and undercover (guard). However, some types of circular saw/plunge saw are exempt from this requirement – although the supplier's usage instructions must state clearly if the riving knife can be omitted.



- A riving knife must be made of steel (rigid) of a thickness corresponding to the cutting width (for carbide blades, it must be 0.3 mm less than the cutting width).
- The riving knife must be set in the same way as stationary circular saws.
- There must be a fixed upper guard that completely covers the blade on the contact plate.
- The under cover must consist of a moveable guard that completely covers the blade under the contact plate.
- The lower guard must automatically move back to a safe position when you remove the saw from the material being cut.
- When sawing, stand next to the saw track in case of possible kick-back of the saw.
- When sawing, the piece of work must be secured using clamps or similar if necessary.
- Wear ear defenders.
- With dust-generating work, use handheld circular saws connected to extractor units or cutting benches with extraction. If the dust concentration has not been reduced sufficiently using an extractor unit, you will need to use suitable respiratory protection.



Minors under 18 must not carry out high-pressure cutting unless this is in connection with industrial skills training (e.g. as apprentices), and only if they have received the proper instruction.

Routers

There is a risk of serious cutting injuries if routers are not used and maintained properly.

- Pull the plug out of the socket when changing the cutting bits.
- Use only milling bits that fit the machine.
- Ensure that milling bits are fitted correctly before use.
- Keep the machine clean so that all functions work.
- Wear ear protection.
- Always wear eye protection, glasses with side shields or tight-fitting glasses.
- For dust-generating work, routers connected to the extraction system or cutting table with extraction must be used. Suitable respiratory protection equipment must be used if the dust concentration is not sufficiently reduced.

POWDER-ACTUATED TOOLS

A powder-actuated tool is a nail gun in which an explosive charge drives a bolt or nail into a solid material.

Powder-actuated tools must either be CE marked in accordance with the Machinery Directive (2006/42/EC) or they must be type-approved by the Danish Working Environment Authority. The type approval number is written as DK + a number followed by A or B, which indicates the gun group.

Powder-actuated tools approved by the Danish Working Environment Authority are divided into groups A and B:

A. Piston guns, where the muzzle velocity for the bolt exceeds 100 m/sec., and projectile guns.

4. MACHINERY AND TOOLS

B. Piston guns, where the muzzle velocity for the bolt is 100 m/sec. or lower.

Normally only type B bolt guns may be used. Type A guns may only be used if it is not possible to use type B guns for technical reasons.

Powder-actuated tools must be designed in such a manner as to incorporate at least two independent safety devices to prevent accidental firing. The fuses must work even if a loaded gun is dropped or subjected to shock.

The manufacturer or his authorised representative in this country must carry out all essential repairs and the prescribed annual inspection. They must issue proof of inspections carried out.

- The user must be at least 18 years old.
- The user must be thoroughly instructed and trained in the proper operation and function of the gun (including all details of the operating instructions and safety regulations as well as inspection and maintenance, daily cleaning and greasing).
- Minors under the age of 18 may only operate powder-actuated tools in connection with industrial skills training, e.g. as apprentices and they have been properly trained and instructed.

Before using a powder-actuated tool, it is necessary to ensure that it is not possible to shoot through an object. If there is a risk of this, you must ensure that nobody is behind the walls etc. in the direction of the fire. Keep unauthorised persons away from the work site. Before firing, it is necessary to put up warning signs in appropriate locations, e.g. in doorways to the risk zone. These signs must bear the words:

WATCH OUT
Powder-actuated tools are in use

Cartridge loading is selected on the basis of usage instructions in respect of the work in question. The correct spall shield must be used, and it may be necessary to acquire a special spall shield.

Firing is not permitted:

- Into brittle or hard materials (e.g. tempered steel, granite and glazed tiles).
- Near to edges so that there is a risk of the bolt being flung back or splinters being broken off.
- Anywhere you have previously attempted to fire in a bolt or nail.
- Against bolts or nails which have not been driven in completely on a previous attempt (double shot).
- Anywhere where sparks may cause fire or explosion.
- If there is a risk of hitting electric cables, gas pipelines and similar.

The work area must be designed such that the operator stands on a firm, secure base.

Cartridges must not be carried loose in a pocket.

The gun must be placed in the storage box when not in use, and this box must then be locked.

When using a powder-actuated tool, the person using it and any assistant he may have must wear:

- a helmet.
- tight-fitting safety glasses.
- Ear defenders which attenuate the sound of shots.

Powder-actuated tools must be subject to inspection at least once a year, and at any other time when necessary. The inspection must be undertaken by the manufacturer or his representative. Proof of the inspection must be issued when the inspection has been completed.

Check the tool regularly in order to see whether it is damaged in any way.

Nail guns

Nail guns are fired with compressed air, electric power or a spring. These guns are every bit as dangerous as powder-actuated tools, except for the smallest types.

Nail guns must have at least two independent safety devices to prevent accidental firing: the trigger and a safety catch. The safety catch is located at the muzzle of the gun. It must have a travel of at least 7 mm before it can be fired.

Either the trigger or the safety catch must have been returned to the safe position before the gun can be fired again. Repeat firing may be permitted with a special safety catch design so that accidentally depressing the safety catch is difficult.

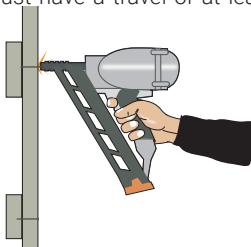

Compressed air-driven nail guns must be connected to the compressed air hose at the gun itself. The highest permissible air pressure must be stated on the gun.

The user must be 18 years of age or older and have received thorough training and instruction in the use of the gun (including all details in the instructions for use and safety regulations, as well as inspection and maintenance). Minors under 18 may operate nail guns if this takes place in connection with industrial skills training, e.g. as apprentices and only if the young person has been properly trained and instructed.

Ear defenders are often required, and eye protection must be worn.

The choice must be made according to the gun supplier's regulations.

There is no age limit of 18 years for nail guns for small staples, pins (max. 0.3 g), etc.

COMPRESSED AIR SYSTEMS AND TOOLS

Compressed air cylinders

Compressed air cylinders must be fitted with:

- rating plate
- safety valve with safety device
- pressure gauge (manometer) marked with a red line that indicates the highest permissible working pressure
- drain cock for condensate in tank.

Cylinders must be positioned so as not to be subject to collision, knocks or blows.

Every four years, an expert must inspect the compressed air vessels inside and outside, where the pressure in bar (ato) x volume in litres is greater than 200.

Compressed air tools

Machines and tools operated using compressed air are subject to the general provisions for machine protection.

Compressed air tools/devices should be used instead of low-voltage devices in tanks, wet rooms, wet concrete and other places with strong discharge to the ground.

Compressed air tools often cause a lot of noise and dust. Therefore, obtain the least noisy tool possible. And use it at the lowest possible pressure. Apply special nozzles to the tool in order to reduce the spread of noise and dust, e.g. a cover or bellows and possibly a filter. If it is not possible to reduce the noise or dust load sufficiently, personal protective equipment must be used.

Minors under 18 are not permitted to work with rotary compressed air tools, hammers, chisels and sandblasting unless this is done in

4. MACHINERY AND TOOLS

connection with industrial skills training, e.g. as apprentices. However, this only applies if they have been properly trained and instructed.

There must be instructions for use in Danish and other languages understood by the other personnel which indicate how to set up, operate and maintain the tool.

Rotary compressed air tools

Grinding wheel tools must be secured against excessive rotational speed of the wheel, even when connecting air at a higher pressure than specified.

Compressed air hammers

When using compressed air hammers, it is necessary to ensure that vibration in the building will not cause a hazard.

Compressed air chisels

Hazardous concentrations of dust, e.g. quartz dust, may be given off when chiselling in concrete and masonry. If it is not possible to extract the dust, the spread should be limited to the surrounding area by means of dust extraction or by spraying water. It is important to remove dust without spreading it – e.g. by means of dust extraction.

Air chisel hammers have a high vibration level. If possible, plan the work so that you use remote operated tools or so that the hand held tool can be supported mechanically. Vibration-damped tools should be selected when acquiring tools. Tools can be dampened with handles made of shock-absorbing material.

You must always wear eye protection, and normally ear defenders and respiratory protection as well, when working with compressed air hammers, and it may also be necessary to wear safety footwear.

Sandblasting

Sandblasting includes blasting with natural sand, steel sand, cast iron sand, baking powder, steel balls, corundum, glass and similar.

Sandblasting with natural sand should be avoided as this contains quartz. Quartz is particularly hazardous to health and poses a risk of silicosis and cancer. Please also note that other hazardous substances may be released from the facades, etc. that are sandblasted, including respirable quartz. This means that personal protective equipment must also be used, even if sand is not used as a blasting agent.

As far as possible, limit the spread of dust during sandblasting outdoors by means of a tarpaulin or similar. Put up warning signs and make sure that sandblasting only takes place in areas where it will not cause inconvenience to others. The operating device must have a hold-down handle (dead man's control). In the case of long hoses (above 40 m), it is advised that the opening function be controlled electrically. Unified air control is not permitted.

When working at low temperatures, the hold-down handle of the jet lance must be secured to prevent incorrect function due to frost in the condensate. This can be done using anti-freeze and dosing equipment.

Personal protective equipment

- Sandblasters must use respiratory protection with an air supply either as a hood which covers the head, neck and shoulders, or as a full mask plus a hood. The air supply to respiratory protection must be provided from a system with an oil separator and possibly also a heating or cooling unit.
- Sandblasters and all other people in the sandblasting area, even for a short time, must wear special dust-repellent workwear such as a close-fitting overalls, tall boots and working gloves with long cuffs.
- Ear defenders are normally necessary.
- Workwear and personal protective equipment must be kept separate from everyday clothes and must not be taken into eating areas.

4. MACHINERY AND TOOLS

Remove used sand as quickly as possible. Cleaning using compressed air is not permitted. Brushing and shovelling may be carried out once the sand has been wetted. The sand may only be reused following special cleaning. Respiratory protection must be used when cleaning.

Before starting work on renovating façades, the municipal authorities must give permission for the work.

Waste must be removed in accordance with the rules laid down by the Ministry for Energy and the Environment.

Wet sandblasting

It is possible to increase the cleaning effect by adding water. Wet sandblasting is not as hazardous to health as dry sandblasting as the quantity of dust in the air here is just 1/10. The sand must be removed while it is wet.

High-pressure cleaning

High-pressure cleaning systems with a maximum pressure above 800 bar present a particular risk and must never be used handheld due to the cutting capacity and powerful kickback effect of the jet.

When working with high-pressure cleaners with pressures in excess of 25 bar, or where the product rating (the maximum pressure in bar times the number of litres per minute) is in excess of 10 000, it is necessary to make sure that:

- no one else is in the work area
- not to spray electrical installations
- that you have a non-slip grip
- that you have a free and unhindered field of work around you
- not to work on ladders

If you work for more than 1/2 hour, you must have a shoulder brace or similar that can relieve your grip on the jet lance.

Danger during use:

- The jet acts as a cutting tool on both work elements and people (injuries can be deep and serious even though the lesions do not appear to be much).

- The jet can be blown back from hollows and curved surfaces.
- Hazardous or toxic substances may be dispersed in mist form.
- Hoses and nozzles may vibrate like compressed air tools (causing white fingers).

It is important to use personal protective equipment. Minors under 18 must not carry out high-pressure cleaning with a working pressure of more than 70 bar (7 MPa) unless this is in connection with industrial skills training (e.g. as apprentices), and only if they have received proper training and instruction.

There must be instructions for use in Danish and other languages that the employees understand, describing how to set up, operate and maintain the high-pressure cleaner.

High-pressure cutting

Never use high-pressure cutters handheld if the pressure is in excess of 800 bar. This is hazardous due to the cutting ability and powerful kickback of the jet.

Nozzles must be secured in special tools.

The cutting area must be inaccessible due to the power of penetration. The working field of the jet must be shielded according to the rules for machine protection.

Mist and noise may occur as with high-pressure cleaning, so respiratory protection and ear defenders may be necessary.

Minors under 18 must not carry out high-pressure cutting unless this is in connection with industrial skills training (e.g. as apprentices), and only if they have received the proper instruction.

There must also be instructions for use in Danish and any other language understood by the personnel that demonstrates how to set up, operate and maintain the machine.

PRESSURISED CYLINDERS

Pressurised cylinders can be either neutral grey or be of the colours shown.



The contents of pressurised cylinders are generally indicated by the colour. The contents of the bottles are also stamped on the pressure cylinder. Take note of the following:

- Cylinder valves must never be lubricated.
- Never throw cylinders or otherwise subject them to shocks, blows or strong loads. They must be secured properly to prevent tipping, rolling or falling.
- Pressurised cylinders must be protected against strong heat. They must be positioned in such a way as to be easily removable in the event of a fire.
- Only the cylinders to be used for the work being carried out may be present at the work site. The valves must be closed on cylinders not being used.
- During transport, the valve's protective cap or collar must be securely mounted and secured with straps or other means of attachment to the vehicle.

Oxygen cylinders must be kept scrupulously clear of any contamination with oil or grease. The valve must be opened slowly. When using e.g. acetylene gas, a check valve must be fitted before the manometer.

The Danish Emergency Management Agency has issued technical regulations on how to design indoor and outdoor stores of larger quantities of gas and inflammable liquids.

A general contractor is often exempted from the normal rules for the transport of dangerous goods. This applies if the following conditions are met simultaneously:

- The products must be used in connection with own (personal) use on the construction site.
- Only small quantities (less than the so-called free quantity, which varies from substance to substance) are transported. See www.beredskabsstyrelsen.dk.
- Containers must not contain more than 450 litres, and it must be ensured that no leakage can occur from the container.

An example of an exception to the rules on dangerous goods, where the driver does not need to have an ADR certificate, is when you bring a couple of canisters of diesel to a mini-excavator you are going to drive yourself – or, for example, if you keep one or more pressurised cylinders in a van for your own work.

If, on the other hand, you supply other employees in the company with products that are dangerous goods, then the transport is covered by the rules for dangerous goods.

Aerosol cans

Aerosol cans must normally not be exposed to temperatures exceeding 40°C or to other overload during use and transport. Cans must not be punctured or discarded until they are completely empty.

Noise may lead to permanently impaired hearing, which is an incurable injury to the inner ear. The risk of permanent hearing damage or hearing impairment is dependent on the strength and duration of the noise.



Hearing damage develops quickly over the first couple of years of exposure to noise. Therefore, it is important from the outset to protect your hearing by acknowledging the risk and attempting to reduce the noise. Many people do not find out that their hearing has been damaged until they become older.

Both tinnitus (ringing/buzzing in the ears) and hyperacusis (abnormal sensitivity to sound) often occur due to noise.

Noise can damage other things besides your hearing. Extreme noise can be a stress factor.

The limit for noise at work sites is 85 dB(A), measured as an average over an eight-hour working day. Unnecessary noise must be avoided, even if the limit value has not been exceeded. The noise must be as low as is technically reasonable and acoustic conditions must be satisfactory.

If there are strong reverberations from the noise, e.g. from a striking tool, measurement of the noise must be increased by 5 dB (A) in order to make a real comparison with the limit value. Strong reverberations are those peaking at more than 115 dB(C) and occurring at least once a minute.

If the peak value exceeds 130-140 dB(C), your hearing may be damaged, even if these noises are short and fairly few in number. Nobody may be exposed to peak values in excess of 137 dB(C).

The employer must ensure that noise is attenuated using technical arrangements. If this is not possible, the employer must limit the amount of time to which individuals are exposed to noise, or organise work in some other way, e.g. by carrying out noisy work separately from other work. A combination of attenuation and administrative arrangements may also provide a solution.

5. NOISE AND VIBRATIONS

If the noise load exceeds 80 dB(A), or if the noise is harmful or extremely unpleasant, the employer must provide ear defenders.

In instances where the noise load is at 85 dB(A) or above, or the peak values are at 137 dB(C) or above, the employer must ensure that suitable ear defenders are worn from the moment work begins.

BFA Building & Construction recommends the use of ear defenders between 80 and 85 dB (A) in any case to ensure that hearing damage is not sustained.

Ear defenders must not attenuate the noise too much, as the user has to be able to communicate with their surroundings and hear warning signals. The attenuation must therefore still allow the user to be able to hear what is happening in their surroundings, i.e. the noise must be attenuated to a level of approx. 75 - 80 dB (A). Pay special attention to the noise level when using ear defenders with built-in music player and radio.

Ear defenders are not a permanent solution to noise problems. The company must continuously assess the conditions with a view to finding other technical or organisational measures to replace hearing protection.

Examples of technical arrangements:

- Reduce noise at the source, for example by switching off or stopping equipment that is not in use and by avoiding metal to metal impacts.
- Reduce noise from noisy machinery, e.g. by using sound-absorbing materials in the driver's cab of construction machinery, encapsulation of compressors, sound locks, etc.
- Ensure a less noisy working method where possible, e.g. by blasting instead of chipping with a jack hammer.
- Limit noisy work, e.g. by making recesses for holes in concrete floors and walls rather than cutting and drilling in them, or by having steel bolts supplied in fixed dimensions that reduce noisy cutting.
- Choose quality tools and machines that are as noiseless as possible.

Examples of other measures:

- Limit the amount of time spent in the noisy environment. This can be done by having a number of workers to undertake/share the work.
- Ensure good maintenance of machines and tools so that worn and noisy parts are replaced or lubricated.
- Plan the work so that the individual workers do not expose each other to noise unnecessarily.

Developers and advisors can help to reduce noise considerably by following the time schedule in the Health and Safety Plan. Developers must ensure that noisy activities from other activities (common areas) are limited, e.g. by encapsulating processes, etc. or establishing noiseless zones. If necessary, use noise absorption screens. Be aware that the supplier has to provide information on the machine's noise level if it generates noise in excess of 70 dB(A) at the operation site. Where relevant, the usage instructions must also provide information on setup and installation with a view to reducing noise. Relevant noise-attenuating arrangements (e.g. enclosure) and use of ear defenders must also be described.

Note that the material/substrate being worked on may affect and increase the noise level.

VIBRATION

Hand and arm vibration

Tingling or numb fingers are the first sign of harm caused by vibration. After a longer period, there is a risk of suffering from "white fingers", which manifests itself by your fingers becoming white, cold and numb in cold weather. Only one or two fingers are affected initially, but if you continue to be exposed to vibration, more of your fingers will turn "white" – and possibly on both hands.



If you experience "white fingers", stop work. Without the sense of touch there is a greater risk of industrial injury. There is a greater risk of industrial accidents if your fingers are numb.

5. NOISE AND VIBRATIONS

Other effects may include permanent loss of sensation and grip, constant tingling in the fingers, pain in the shoulders and joints and an increased risk of osteoarthritis.

The risk of vibration damage depends on how much vibration you are exposed to during an eight-hour working day. In general, injuries can be avoided if the daily vibration load does not exceed 2.5 m/s^2 .

A vibration load of 2.5 m/s^2 is equivalent to being exposed to a constant vibration level of:

- 2.5 m/s^2 for 8 hours
- 3.5 m/s^2 for 4 hours
- 5 m/s^2 for 2 hours
- 7 m/s^2 for 1 hour
- 10 m/s^2 for 0.5 hours

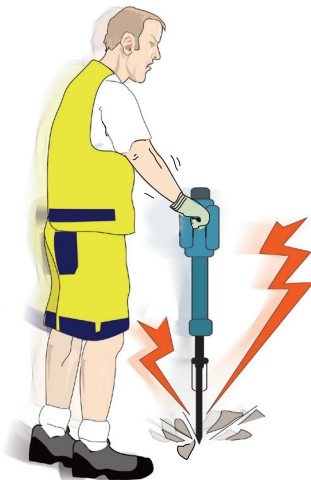

The daily vibration load must not exceed 5 m/s^2 . This limit is absolute and must not be exceeded. The action value describes when the employer must act to reduce the load. The action value is set to 2.5 m/s^2 . With a vibration load between 2.5 and 5 m/s^2 , work can continue. However, you should investigate the cause of the high level of vibration and try to reduce it as much as possible. This can be achieved by means of planning and by using technical arrangements.

Work must be planned and executed so that nobody is exposed to harmful vibration. Technical arrangements must be used, or the exposure time must be limited.

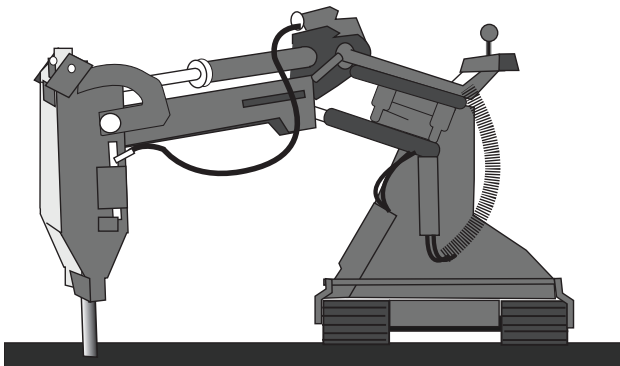

The following arrangements may reduce the load:

- Use less vibrating methods such as blasting, diamond cutting and water jet cutting
- Plan the work so that it gives the least possible vibration
- Replace handheld tools if possible, e.g. by using remote tools/machines
- Maintain tools regularly
- Think about the vibration level when buying new machines or tools.

The supplier must provide information about hand/arm vibration in user instructions, sales material, etc. when 2.5 m/s^2 is exceeded.

Test several different machines/tools, or if necessary, use a working environment advisor when assessing a supplier's information on the vibration level of a tool or machine.

In addition to the other anti-vibration measures, anti-vibration gloves can be used, even though they may only have a very limited effect. Gloves only dampen high-frequency vibration and will only lessen the impact sensation of the hammer stroke. The risk of getting white fingers will remain the same. The same is true for most heavy tools in the building and construction industry.

Full-body vibration

 Full-body vibration is vibration transmitted to the entire body, risking the health and safety of employees by causing pain in the lumbar region and injury to the spine.

Whole body vibrations are transmitted - to drivers of mobile machinery, for example, through seats and floors, or to people who are located near vibrating machines, e.g. vibration screens.

The greater the intensity of the vibration and the longer it goes on for, the greater the risk of your body being affected. Rest periods may reduce the effect.

The daily vibration load describes how much vibration a person is exposed to over an eight-hour working day. The daily load is a combination of vibration intensity and the amount of time for which you are exposed to it.

Vibration acceleration is measured in m/s^2 in three directions perpendicular to each other.

Action values

The action value describes when the employer must take action to reduce the load. The action value is set to 2.5 m/s^2 . With a vibration load between 2.5 and 5 m/s^2 , work can continue. However, you should investigate the cause of the high level of vibration and try to reduce it as much as possible. This can be achieved by means of planning and by using technical arrangements.

Limit value

The limit value means that work must not be carried out with the technical equipment if the limit value is exceeded. If the limit value is exceeded, measures must be taken to get below the limit value.

Avoid unnecessary vibration loads and ensure that the load is as small as possible. There is a full-body vibration limit of 1.15 m/s^2 which must not be exceeded, as well as an action value $A(8)$ of 0.5 m/s^2 .

The risk of injury increases in fixed working positions and with frequent twisting of your back. The same is true when your muscles are tired, or when your back is compressed following hard physical work. Jolts and unexpected movements caused, for example, by uneven surfaces or minor collisions also increase the risk of injury.

Purchasing machinery

It is important to ensure that the ergonomics of the driver's cab are appropriate. There should be a clear field of vision for the operator and all controls and switches must be located so that the operator can perform the job without having to twist and turn in the chair.

It is also important to realise that an inefficient machine with too little capacity for the job will result in longer exposure times (generally, the heavier machines also vibrate less).

- Choose machines with low vibration level
- If possible, purchase vehicles with suspension
- If necessary, involve a working environment advisor in the assessment
- Suppliers of machinery are obliged to:
 - Provide machines with low vibration levels
 - Provide vehicles with seats that limit driver vibration as far as reasonably possible
 - Inform about the vibration strength. If it exceeds 0.5 m/s^2 , the intensity must be stated.

Vibration strength must be stated in Danish in the user instructions and sales material.

Reducing the risk of injury

- Drive at a speed that is not too high for the surface on which you are driving.
- Select and mark roadways bypassing sewer covers, potholes, cobblestones, road signs, etc.
- If possible, level the sections on which the vehicle is used frequently.
- Avoid solid wheels wherever possible.
- Use a seat suitable for the vehicle, including the vibration frequency of the machine. The seat must offer good lumbar support in relation to the movements involved in the work. It must be maintained, easy to adjust and adjusted to suit the driver. The driver must have received thorough instruction on how to adjust the seat.
- The seat should have forward/backward movement settings, backrest inclination, adjustments for the driver's weight and any variable lumbar support. Good lumbar support and adjustments for the driver's weight are particularly important in terms of vibration.
- If possible, adjust steering or controls to suit the driver.

The tyres on the vehicle must be correct and have the correct pressure. Make sure that the vehicle's suspension, shock absorbers, etc. are well maintained.

CHEMICALS AND DUST

The effect of chemicals

Chemicals are everywhere. The way they effect us can come from products with a planned chemical effect - such as paint, foam joints and flooring. Effects may also arise, for example, from work processes in which dust, steam, smoke, waste, etc. is generated from insulation materials, wood, concrete, welding and soldering work. Demolition and renovation tasks in existing buildings may also be affected by residues of asbestos, PCB, lead and contaminated soil.

In some cases it is possible to see, smell or taste the chemicals. Among other things, you can see dust in the air and see, smell or taste some forms of smoke, steam and gas. Other chemical effects are difficult or impossible to notice. When working with chemical products, read the label and safety data sheet for information about how they are hazardous and how to protect against exposure. In order to protect against dust, steam, smoke, waste, etc. generated from a work process, it may be necessary to carry out measurements unless experience shows what needs to be taken care of. Knowledge of asbestos, PCB, lead and other harmful substances in older buildings is obtained through preliminary studies of the buildings that are renovated, rebuilt or demolished. It is the employer's responsibility to ensure that work with chemicals and materials is carried out in a safe and responsible manner, so that unnecessary impact does not occur. Before starting work, you must:

- carry out a chemical risk assessment
- prevent the adverse effect of chemicals with the STOP principle
- instruct, train and supervise

This applies both when working with chemical products that are hazard-labelled and when working with or developing chemical substances, waste, dust, steam and smoke that are not hazard-labelled, but which can be dangerous if exposed to them.

Chemical risk assessment

When employees can be exposed to harmful chemicals in the workplace, the company must:

- make a list of the hazardous chemical products to which employees may be exposed. The list must refer to relevant safety information leaflets.
- ensure that the company has safety information leaflets for all chemical products and that they are accessible to the employees where they work - preferably digitally. Please note that you must obtain your own safety data information for products marked on the label with: "Safety information available on request".
- carry out a chemical risk assessment as part of the company workplace assessment. The result of the risk assessment must be in writing, e.g. in the form of work instructions, pictograms, drawings or films, which can be used in the instruction and training of employees. The employer must involve the employees in this. The risk assessment must include both the chemical products that are hazard-labelled and the chemical substances, waste, dust, steam, smoke, etc. from the work process that are not hazard-labelled, but which may pose a risk if exposed to them.

Substances and materials can advantageously be grouped according to the work processes in which they occur, are released from or formed. If there is a risk of being subjected to effects from several different substances or materials, an overall assessment of the risk must be carried out.

If a system for preparing workplace instructions is already used in the work environment, this can continue to be used as the risk assessment and can provide a starting point for the instruction.

The following elements must be included in the overall assessment:

- Hazardous properties of substances and materials:

Refer to the label or SDS points 2, 3, 10 and 11 to see how the substance or material is hazardous. Remember to also look at the danger of waste, welding fumes or dust from drilling, grinding, demolition, etc.

- Level, type and duration of exposure: See points 7, 8 and 9 of the safety data sheet for how employees may be exposed to the substance or material. This could be by inhalation, ingestion or contact with the skin, hands or eyes. This could be before, during and after the work and during repair and maintenance in the workplace. Remember to look at all aspects of the activity. If in doubt, ask the supplier. Instructions can also be found on BFA-BA.dk or on the Danish Working Environment Authority website.
- Circumstances of working with hazardous substances and materials, including quantities.
- The effect of preventive measures taken or to be taken.
- Experience from occupational medical investigations, if available.
- The Danish Working Environment Authority's limit values.
- Supplier information on health and safety.

If the chemical risk assessment shows that there are problems that cannot be solved here and now, temporary measures must be implemented to protect the employees until a permanent solution can be established. The problem is implemented in the ordinary WPA action plan with solution and deadline.

Revise the risk assessment if there are significant changes in the work, the way the company works with the substances and materials or the classification of a substance that has had an impact on the risk assessment. The risk assessment must be revised at least every three years.

On BFA's website www.styrpaastofferne.dk there is further information and examples of how to carry out a chemical risk assessment with written instructions.

Prevention according to the STOP principle

If there are hazardous chemicals to which employees may be exposed, prevention must be carried out according to the STOP principle:

- **Substitution:** Remove the substance and material from the workplace, replace it with a less hazardous substance or material, or use a less hazardous method of working.

6. CHEMICALS AND DUST

- **Technical measures:** Isolate the chemical and material by e.g. encapsulating the work process or establishing process ventilation, e.g. in the form of local exhaust ventilation.
- **Organisational measures:** Limit the number of employees who are exposed and/or the length of time they are exposed, e.g. by separating workplaces or by job rotation. Prepare procedures for personal hygiene and cleaning so that chemicals are not spread.
- **Personal protective equipment,** e.g. respiratory protection, gloves, overalls or eye protection, when all other precautions have been implemented and there is still a risk of impact.

Substitution:

Contractors and employers must replace hazardous substances and materials with non-hazardous, less hazardous or less harmful and irritating substances and materials, and assess whether it is possible to use a work process that is non-hazardous or less dangerous (substitution principle). Substitution should be performed even if the effects are insignificant. Only if the impact is insignificant can financial consequences be taken into account when weighing the technical consequences with regard to health and safety.

The company's working environment department must be involved in the assessment of possible substitutions.

If it is not possible to replace a hazardous substance or material for technical or financial reasons, the Danish Working Environment Authority may require documentation for this.

The substitution requirement also applies to the project planner. This means that the project planner/contractor must not indicate the use of a substance or material in the project specifications that exceeds general industry practice and which may be dangerous to or otherwise impair health and safety if it can be replaced by something less dangerous.

Training and instruction when working with chemicals

Training and instruction of employees in working with and exposure to hazardous chemicals must at least include the following and must take into account:

- Hazardous substances and materials present at the workplace and the risk of working with them. The company's list of harmful substances and the chemical risk assessment can be used here.
- How to carry out the work so that the substances and materials are handled, used and stored correctly.
- Use of safety measures during work:
 - Which safety precautions must be used.
 - How to properly store and clean personal protective equipment such as respiratory protection equipment and gloves after use. This also applies to the company's work processes, where there may be a risk of exposure to hazardous substances and materials, e.g. dust.
- Measures in the event of accidents, fire, spills, etc.
- Disposal of substances and materials and protective equipment after use and handling of waste.

The instruction is oral, but must be supported by written material when employees may be exposed to particularly hazardous substances and materials, particularly complicated work processes and conditions, or if the chemical risk assessment so requires. Written material in this context may include work instructions, pictograms, drawings or films.

The instruction must be adapted to the work situation and be understandable to the employees.

Repeat the instruction regularly and instruct again when changes are made to a work process.

Carry out monitoring to ensure that training and instruction is sufficient and is being followed. If the work is not carried out safely, repeat the risk assessment and adapt the instruction so that it is.

Limit values and measurements

Working environment legislation contains limit values for air pollution for a number of substances and materials, including dust. Fixed limit values must be observed. The limit value cannot be used in isolation, but is included in an overall assessment of the working environment, as it is a fundamental requirement in the rules that unnecessary influence from substances and materials must be avoided.

It is not enough for a limit value to be observed in a workplace if you can further limit the risk of exposure in the working environment by replacing a hazardous substance or material with one that is not hazardous or less hazardous. It may also involve the use of technical measures, e.g. process suction, room ventilation, screening and cleaning, as well as organisational measures or the use of suitable personal protective equipment, e.g. respiratory protection equipment and gloves, if the work cannot be carried out in a completely safe manner in other respects. According to the rules, these protective measures must always be in place, regardless of the limit value.

People are often exposed to several substances at once, e.g. several types of vapour from solvents or welding smoke containing different substances, all of which are harmful. When several substances occur at the same time, they may have a reinforcing or potentially debilitating effect. If air measurements are taken in the working environment, a more detailed sum formula from the Executive Order on limit values must be used to calculate the total impact when there is no specific information on the effects of the substances. In addition to complying with the limit value for the individual substances and materials, a value of 1 or less must be complied with for the sum of the total impact.

When exposure to dust, smoke, steam or oil mist is combined with hard physical work, for example, there is a risk of increased exposure via the airways, as you breathe more forcefully during hard work. The concentration of any hazardous substances in the air in the workplace must generally be kept as far below a limit value as possible. If in doubt, consult a qualified health and safety advisor.

Use of measurements

According to the rules on working with substances and materials, if an employer cannot clearly demonstrate with special measures that adequate prevention and protection has been achieved, the employer must regularly, and when changes occur in conditions that may involve a risk to the employees' influence from a hazardous substance or material, carry out measurements, especially when this is deemed necessary to help ensure compliance with limit values in the working environment. If hazardous substances and materials are found in the workplace, a chemical risk assessment must be prepared in accordance with the rules, and this may be a basis for assessing whether measurements should be included in the company's control of the working environment.

Measurements can be taken as documentation measurements or as guidelines. Documentation measurements can be used to show whether a threshold value has been met, while indicative measurements can, among other things, be used as ongoing control of the conditions and as the basis for the company's own assessment of the effectiveness of the measures taken.

If there is any doubt as to whether the air quality at a workplace complies with the limit values, then contact a qualified working environment advisor.





Classification and labelling

Chemical products, including substances and materials, must be classified and labelled in accordance with the CLP Regulation.

Hazardous, explosive, flammable or environmentally hazardous substances and products are classified in hazard classes and are labelled as shown in the table.

Today, only products with the new hazard symbols may be used. For chemical products, all substances and materials must be labelled with the new pictograms. Substances and materials with orange hazard symbols and labelling in accordance with the old rules must be re-labelled or disposed of in a lawful manner.

6. CHEMICALS AND DUST

	Irritates on contact with the skin and eyes. May cause allergic reaction after contact with skin.
	Highly dangerous or toxic on ingestion, skin contact or inhalation.
	Carcinogenic. Mutagenic. Damages reproductive health. May cause allergic reaction if inhaled. Specific organ damage.
	Damages the skin. Causes severe eye damage. Corrodes metals.
	Flammable.
	Pressurised, e.g. gas cylinders.
	Products which are harmful to the environment.

H and P phrases

For all chemical products there is information about special hazards and necessary safety precautions. These are stated in the so-called hazard warnings and safety terminology, which must appear on the hazard label on the packaging and in the safety information leaflet.

Toxic substances and products

Companies that use toxic substances and products must notify the Danish Working Environment Authority via virk.dk. This must be done on a special form which is available from police stations or at the regional Working Environment Authority Centres.



The registration is valid for three years.

Toxic substances and products must be stored securely in a locked cupboard or room provided with a warning sign. These are generally products that are marked with pictograms with a skull and exploding man, e.g. flux.

Code numbering



A range of products have to have a code number. This applies to paints, but also to other products such as wood preservatives, adhesives and sealants. The code number can be found either on the packaging or in the supplier's safety data sheet.

You can use the code number to select the correct product (select products with the lowest possible code number as a starting point) and to determine which safety measures, e.g. process ventilation or personal protective equipment, are to be used.

The code number comprises two digits linked with a hyphen. The codes run from 00-1 to 5-6.

Essentially the higher the digit, the greater the hazard. A substance coded 5-6 is the most harmful to health.

A product coded 00-1 is the least hazardous product currently technically available.

Please note that Annex 2 of the Executive Order on work with code-numbered products contains a comprehensive overview of the precise security measures to be applied to the individual types of work and work processes.

Example of use of code numbers when painting

The digit before the hyphen

The digit before the hyphen is used to establish safety measures that can prevent inhalation of vapours, including from organic solvents.

6. CHEMICALS AND DUST

Example of digits before the hyphen for indoor painting on large surfaces - with spatula, brush, roller, etc.:

00 means that there are no special measures

0 means that there are no special measures

1 means that at least a gas filter mask must be used

2 means that at least a half mask with an air supply must be used

3 means that at least a full face mask with an air supply must be used

4 means that at least a full face mask with an air supply must be used

5 means that at least a full face mask with an air supply must be used

The higher the digit before the hyphen, the greater the need to use respiratory protection and process ventilation to provide protection against the risk of inhalation. Water-based paints typically have a code number of 00-1 (1993). Alkyd paints with mineral turpentine typically have a code number of 2-1 (1993). Products based on xylene as a solvent typically have a code number of 4-3 (1993).

The digit after the hyphen

The digit after the hyphen is used to establish safety arrangements which may prevent contact with the skin and eyes, inhalation of droplets, dust from spray mist and any ingestion, e.g. by smoking or eating. spray mist.

Example for digits after the hyphen for indoor painting work:

1 means that at least gloves must be worn

2 means that at least gloves must be worn

3 means that at least gloves must be worn

4 means that at least gloves, face shield, hood, protective clothing must be worn

5 means that at least gloves, face shield, hood, protective clothing must be worn

6 means that at least gloves, face shield, hood, protective clothing must be worn

The requirements for safety measures also depend on whether the work takes place indoors or outdoors, whether it is small or large surfaces, or which application methods are used, e.g. spray painting, etc.

Use of code numbers

The code marking can help determine which PPE to use. The Danish Working Environment Authority has forms in which you can see which protective equipment must be used. This depends on code marking, large or small surfaces and application method.

The entire table with the small notes can be found in the Danish Working Environment Authority's Executive Order on work with code-numbered products, Annex 2.

In case of doubt

If in doubt or facing a borderline case, always choose the most effective protection.

If the temperature in rooms or on surfaces, e.g. radiators, is above normal room temperature, the number before the hyphen in the code number must be increased by one.

PAINT

Paint contains - among other things - binders and pigments, and it may also contain different types of solvents. Do not inhale paint fumes and do not get on your skin. When spray-painting, there is a risk of inhaling both aerosols (spray mist) and vapours from solvents. Aerosol may contain pigments that are harmful to health and is therefore dangerous to inhale. Therefore, mark off the paint area or use a roller instead of a spray gun.



Paint may also contain irritant and allergenic substances. This applies in particular to water-based paints that most often contain preservatives (biocides, e.g. MI and MI-like substances). These substances are

6. CHEMICALS AND DUST

highly allergenic when they evaporate into the air and on contact with skin. Ensure good ventilation and avoid skin contact when working with water-based paints. Or use paints without these preservatives. Paint containing the preservative MI must be marked with information about this.

Thinning of paint

If you thin a paint, the safety rules may change. Therefore, the code number of the ready-to-use mixture (after dilution) must always be stated. For example, dilution of paint (coded 2-2) with a thinner (coded 3-1) will normally change the code to 3-2 and thus require stricter safety rules.

Prohibitions

Maximum permitted code numbers are set for certain types of painting work. This is applicable to painting work taking place indoors, for example.

ORGANIC SOLVENTS

Organic solvents are used for degreasing and cleaning and may also be included in paints and adhesives, for example. Organic solvents will normally be classified as hazardous substances.

Health risks

Organic solvents may damage a number of organs and are absorbed into the body through the lungs or skin. These injuries may be acute or chronic. Acute injury manifests itself as headache, dizziness, sensation of intoxication and tiredness. Organic solvents may also irritate the mucous membranes in the eyes, nose and throat and cause eczema.

If you are exposed to organic solvents over a long period, this may cause chronic damage to the brain and the nervous system. The symptoms may include memory loss, nervousness and irritability, followed by fairly

severe mental changes, e.g. depression. Some organic solvents can cause cancer and reproductive harm (foetal damage).

Risk of fire and explosion

Organic solvents are often flammable, and their vapours can form explosive mixtures when exposed to the air. When heated, compounds with organic solvents containing chlorine may be split and give off phosgene (a toxic gas).

Flammable and explosive materials require special arrangements.

Use respiratory protection with an air supply (from a compressor placed in an uncontaminated area, or from air cylinders) when working with organic solvents with a boiling point lower than 65°C, as these may be difficult to slow down with a carbon filter.

Precautions

Good advice on the use and storage of solvents:

- Always use the least harmful solvent.
- Follow the instructions in the supplier's safety data sheet and prepare a chemical risk assessment.
- Avoid smoking and use of open flames (welding, etc.).
- Ensure effective ventilation.
- Use suitable respiratory protection if it is not possible to avoid inhalation of the vapours in any other way.
- Ensure that cleaned and impregnated items are completely dry before further processing.
- Protect the skin from solvents with suitable personal protective equipment, e.g. gloves, coveralls, apron and sleeves, depending on the nature of the work.
- Immediately remove soaked clothing and wash the skin if it is affected.
- Do not leave solvent wipes lying out in open containers or hidden in pockets.

6. CHEMICALS AND DUST

- Never clean the skin with solvents.
- Protect your eyes from splashes and splashes. If eye irritation does not pass over when you flush your eyes with water, see a doctor.
- Entrances to explosion-hazard areas must be clearly marked with safety signs.

WALLPAPER REMOVAL

Dampen the wallpaper so that it can be scraped off.

Apply wallpaper paste to the wall, then cover with thin plastic until the next day, after which the moist wallpaper can be scraped off.

IMPREGNATED WOOD

Pressure-impregnated wood from countries outside the EU may contain arsenic and chromium, as can old pressure-impregnated wood. Wood containing arsenic may not, however, be produced, imported, sold or used in Denmark.

In general, pressure-impregnated wood contains different types of chemicals, which means that the following advice for the work should be followed.

Using and sawing pressure-impregnated wood:

- Use pressure-impregnated wood only when necessary to prevent fungal and insect infestations. In many instances, it is possible to use wood varieties with high levels of natural impregnation.
- Use wood impregnated with the least hazardous agents.
- Only use wood for which the impregnation agent has been sufficiently steamed off. The humidity in the wood must not exceed 25-30%.
- Avoid contact of the pressure-impregnated wood with the skin.

Use suitable gloves and aprons, e.g. if the wood gets wet in the rain. Process suction must be available on the tool connected to an H-class vacuum cleaner if you are sawing the impregnated wood or if it is to be processed in any other way. As far as possible, avoid sawing the wood beyond what is necessary. If necessary, use suitable respiratory protection (at least half mask with P2 filter). Ensure that storage and work with pressure-impregnated wood takes place in a well-ventilated area.

If wood is impregnated with creosote or arsenic, it is generally considered hazardous waste and must be disposed of as such. However, if the wood is simply surface-treated or other agents have been used, the Danish Environmental Protection Agency assesses that this does not normally constitute hazardous waste.

FORM OILS

Form oils may be based on mineral, vegetable or synthetic oils and may contain solvents and certain additives. Mineral form oils will be classified in most instances as hazardous substances or materials.

Contact with form oil can cause skin problems in the form of redness, irritation, swelling, blisters and eczema. Long-term contact with mineral oils may also cause skin cancer. Aerosols/spray mists may cause nausea and headaches when inhaled and result in lung diseases.

Avoid skin contact with form oil. Form oil must be applied with a brush or roller wherever possible. If the finish requires the form oil to be sprayed on, use at least filtered respiratory protection using a P2A2 filter.

In addition, there may be a risk of coming into contact with form oil when striking and removing formwork.

Safety arrangements

- Use or change to the least harmful form oils.
- Check in advance how great the health hazard is when using a product and get clear and thorough information on the hazard.
- Get clear and thorough instructions on how to do the work and on which PPE to use.

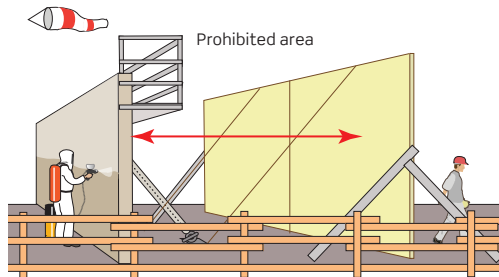

Work site layout

Set up the work site so that neither the user nor anyone else is contaminated by spray, splashes and spray mist (aerosols). Be aware of wind strength and direction.

Protective equipment and hygiene

When spraying, it is normally necessary to use respiratory protection and oilproof overalls with a hood and gloves, etc. Use an oilproof apron and gloves when applying the oil with a brush or roller. Special work clothes are often required when working with oiled formwork elements, etc.

Workwear contaminated with form oil must be kept separate from everyday clothes. When work is complete, it is important to wash and care for the skin and body. Therefore, it is necessary to make available suitable cleaning agents for the skin, soap, creams for skin care and clean and dry towels or disposable towels.

EPOXY AND ISOCYANATES

Epoxy compounds are highly allergenic substances.



Allergies may occur after even a short period. Contact eczema (hypersensitivity eczema) occurs particularly on the hands and appears as redness, itching, small bumps and fluid-filled blisters. In the case of severe eczema, the skin swells up and suppurates.



Epoxy is used in products such as paints, moisture barriers, floor coverings, sealants for concrete, joint sealants and adhesives. Epoxy is part of a two-component system. Sometimes the products are delivered ready-mixed. People with eczema, epoxy allergies or heavy sweats must not work with epoxy products.

Isocyanates (polyurethane or PU) may cause eczema and allergic asthma. Asthma manifests itself in attacks of shortness of breath when exposed to the substances. Several isocyanates are suspected of being able to cause cancer and are on the Working Environment Authority's cancer list.

Isocyanates are used in products such as paints, adhesives, roof pointing products, joint sealants, floor coverings and soft and hard foam, e.g. preinsulated district heating pipes. Isocyanates are part of a two-component system. Sometimes the products are delivered ready-mixed.

Persons suffering from asthma, eczema, isocyanate allergy, chronic lung diseases or with easily sweating hands must not work with isocyanate products.

Spray prohibition

It is in principle forbidden to spray using products outside spray booths and spray cabins, where there must be effective ventilation. However, spraying is permitted in some situations, e.g. spraying of wooden flooring in some sports halls and on outdoor sports tracks. In some situations, there may be time restrictions on this type of work; it all depends on the work situation. This depends on the work situation. Spraying must be reported to the Danish Working Environment Authority.

Training and instruction

Any person working with epoxy or isocyanate products must receive special training. There is a general training course and a short training course for work with sealants in closed containers. In addition, the employer must ensure that sufficient instruction is given on how specific work is to be carried out.

Precautions for the use of epoxy and isocyanates

A chemical risk assessment must be carried out before working with epoxy and isocyanate materials. Employees must be trained, and verbal instruction must be given - supported by written material.



Suitable disposable gloves and protective clothing must be worn as it is important to avoid contact with the skin. Also avoid inhalation of any vapours or aerosols by using suitable respiratory protection equipment. For internal work and major tasks, the need to establish ventilation in combination with personal protective equipment must be assessed. Be aware that there may be a risk of steam throughout the curing period.

Be aware that heating, e.g. when grinding hardened products, may emit isocyanates.

Some epoxy products have a very irritating odour, even at low concentrations. Therefore, ensure separation/demarcation from other professional groups, work tasks. Therefore, please also be aware of this issue when purchasing products.



Do not eat, drink or smoke at the workplace itself.

Only those working with the products are permitted to remain within the work area, which must display warning signs. Spillages, residues, empty packaging, discarded workwear and used disposable towels must be placed in special waste containers which clearly describe the contents.

Welfare facilities

There must be separate changing rooms in which footwear and workwear are stored separately. These must not be used by anyone other than those working with epoxy and isocyanates. There must also be access to the toilet and bath with cold and hot water, as well as a canteen that is kept free of epoxy and isocyanates, i.e. employees must not wear dirty protective equipment and workwear in the canteen.

In the workplace where the product is used, there must be unhindered access to hand washing with hot running water, cleaning agents and suitable skin cream. Taps must not be hand-operated, but must instead be pedal-, sensor- or elbow-operated.

Cleaning must be carried out regularly in changing rooms, bathrooms and dining rooms.

6. CHEMICALS AND DUST

Good personal hygiene is important. Wash your face, forearms and hands before lunch breaks and going to the toilet, and always at the end of the working day. If necessary, bathe at the end of the working day. IMPORTANT NOTE: In case of any skin contact, wash thoroughly to avoid allergic reaction.

First aid equipment including eyewash must be available close to the workplace.

ASPHALT (BITUMEN)



Work with asphalt includes laying different types of road asphalt, laying mastic asphalt, roofing work using bitumen products, bridge insulation and dampproofing, etc. using bitumen products. Exposure to smoke from roofing is covered by the Danish Working Environment Authority's rules on work with carcinogens and materials.

Asphalt products can be classified as hazardous substances or materials.

When working with asphalt materials, air contamination which is harmful to health may occur, and some products may cause eczema if they come into contact with the skin.

If asphalt materials cause problems with regard to health and safety, they must be replaced with other, less hazardous materials.

Safety arrangements

A chemical risk assessment must be carried out before working with asphalt and bitumen materials. Employees must be trained and verbal instruction must be given - supported by written material. This also applies to work with recycled materials.

Bitumen solutions which contain organic solvents for adhesion must not be used. However, if this is necessary, e.g. in terms of traffic flow, they can be used during the period 1 October to 1 April after consultation with the working environment organisation.

Technically suitable adhesives and coatings are currently available to replace products with organic solvents.

The temperature must be as low as possible when working with asphalt materials. In addition, it is always important to observe the set maximum usage temperature for bitumen types.

Natural and mechanical ventilation

Outside, asphalt work must be planned so that it does not take place directly in the smoke flue and employees are not exposed to asphalt smoke. The direction of the wind must be taken into account.

Measures must be taken, e.g. in the form of encapsulation, use of lids on boiling tubs, process ventilation, driver's cabs with overpressure, etc., to prevent air pollution that is harmful to health if inhaled.

When using machines, exposure to asphalt smoke can be avoided by using drivers' cabs with overpressure or filters. Or by using other technical solutions, e.g. heat shields over rollers. In the case of asphalt work in e.g. courtyards and other areas with poor natural ventilation, the smoke can be removed mechanically, e.g. by means of a blower.

In the case of indoor asphalt work in industrial and warehouse buildings or, for example, with asphalt work in tunnels, smoke and exhaust fumes can be removed by process ventilation.

Personal protective equipment

Respiratory protection must always be available which must be used when it is not possible in any other way to prevent the development of air contamination which is harmful to health. Normally, a half mask with a combined filter A2P2 or turbo mask with at least the same degree of protection must be used. The filter mask must not be used for more than a total of 3 hours per day. If the work is expected to extend beyond 3 hours, a suitable turbo mask must be used from commencement of work. The filter must be changed regularly before the air contamination leaks through.

6. CHEMICALS AND DUST

If there is a risk of contact with the skin, use personal protective equipment such as suitable gloves, footwear and protective clothing to prevent penetration of splashes and particles and any solvents. In case of work with hot asphalt materials, the personal protective equipment must be able to withstand heat. The employer provides protective clothing, gloves and footwear – which must be changed regularly. Employees are obliged to wear personal protective equipment (PPE) and the employer is responsible for its washing and maintenance. PPE must not be taken home.

If the PPE becomes saturated, replace it immediately. A change of PPE must always be available.

Training

The work may only be performed by persons who have undergone special training approved by the Danish Working Environment Authority. During the period until a training course has been completed, instruction on safety during asphalt work must be repeated at 4-week intervals until the training has been completed.

The instruction must be carried out by a person who has completed the training.

Welfare and health measures

There must be access to changing rooms, toilets and bathrooms with cold and hot water and canteens that are kept free of asphalt.

If work is not carried out near the site hut or assembly point with bathrooms, water and cleaning agents and towels must be brought to the work site. A crew car and driver's cab cannot normally be considered as a welfare facility.

Changing rooms, bathrooms and dining rooms must be cleaned regularly.

DUST

Dust on the construction site is often a problem. It hampers work, can cause various health issues and problems for the construction process and its quality.

It is possible to prevent and limit exposure to dust. This is done by using the following principle in the following order:

1. Remove the source of the problem
 2. Limit the exposure
 3. Protect against exposure. See further details below.
-
1. Many dust problems can already be prevented in the planning of a building and construction work; for example by using structures and elements that do not require on-site treatment during the subsequent construction process. For example:
 - by ordering concrete elements in exact dimensions and with the necessary recesses to avoid subsequent cutting and drilling in the concrete
 - by ordering pre-cut cladding boards, details, window plates, etc.
 - by using materials that do not create dust, e.g. wet mortar instead of dry mortar or ready-to-use and dust-reduced tile adhesive instead of dry products.
 2. If you use materials and work processes that are dusty, try to remove or limit the contamination at the dust source itself. This can, for example, be done in the following way:
 - Use process suction connected to a suitable CE-marked vacuum cleaner, class H, if there are carcinogens in the dust that are present in most construction site dust. Remember that this must be a dust extractor.

6. CHEMICALS AND DUST

- Use air purifiers to generally limit the amount of dust. Continuous cleaning of surfaces - either by vacuuming or wet scraping/ sweeping. Work from top to bottom as far as possible to avoid dust contamination of finished areas.
 - Use working methods in which the employees are separated from dust generation, e.g. by using construction machines equipped with pressurised cabins.
 - Keep dust-generating work processes separate from non-dusty work. Separate the dust-generating work area from other work using dust walls or other flashing or organise the work so that dust-generating work processes do not take place at the same time as non-generating work.
 - Normally, the extracted air must not be recirculated in case the dust contains carcinogens.
3. If dust creation cannot be avoided or otherwise be counteracted and is likely to be serious, personal protective equipment must be worn.

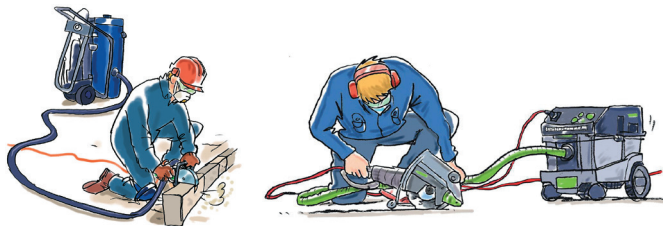

VACUUM CLEANER

As the dust at a building and construction site will almost always contain carcinogens, such as respirable quartz dust and wood dust from hardwood, it is recommended that a vacuum cleaner with class H filter is used. This can be used for process vacuuming on tools as well as cleaning, as the dust will generally contain carcinogenic dust, such as respirable quartz or wood dust at some point.



If it is to be used for process suction, the vacuum cleaner must be of the "dust extractor" type. All vacuum cleaners must be CE marked.

When using, pay particular attention to the vacuum cleaner's alarm (light or sound), which signals when the vacuum cleaner is full and losing power.

Vacuum cleaner type selection table for different applications

Filter type	Used in connection with
L	Cannot be used on construction sites
M	Examples of dust: <ul style="list-style-type: none"> • filler, plaster, tile adhesive and paint • lacquer • small amounts of softwood dust
H	Examples of respirable dust that can cause lung diseases, be carcinogenic or cause nerve damage: <ul style="list-style-type: none"> • crystalline quartz dust, e.g. concrete and stone • hardwood dust • high concentrations of softwood dust over a long period of time • asbestos, lead, KP and PCB dust

ASBESTOS

Asbestos has been used up to 1990 in a wide range of building materials, such as pipe and boiler insulation and various panel materials. Asbestos can cause asbestosis and cancer of the lungs and membranes. People who smoke and are also exposed to asbestos have a greatly increased risk of developing lung cancer.



6. CHEMICALS AND DUST

Use of asbestos or materials containing asbestos is prohibited, but demolishing, repairing and maintaining buildings, etc. in which materials containing asbestos have been used is permitted. However, high-pressure spraying of materials containing asbestos (including asbestos cement tile roofing) is prohibited. Under certain conditions, exemptions can be granted for the use of closed cleaning machines with water collection.

Materials containing asbestos that have been removed or otherwise taken from their original location may not be set up again or reused in any way. This also applies even if the materials are undamaged.

Working with materials containing asbestos is particularly dangerous work. The construction site's Health and Safety Plan (HSP) must therefore state where there is asbestos and when work involving intervention with asbestos-containing materials will be carried out.

Minors under 18 must not work with materials containing asbestos unless they are part of a qualifying training course.

Preliminary examination for asbestos

Before a demolition, renovation or maintenance project is commenced, the client must ensure that feasibility studies have been carried out for asbestos. This applies when at least two companies are expected to perform the work at the same time. The results of the preliminary studies must form the basis for the preparation of a Health and Safety Plan (HSP). It is important for all involved to be aware of whether preliminary studies have been carried out.

The client has a duty to disclose known knowledge of asbestos in the building. For smaller service tasks, such as repair, maintenance and installation in private homes, it is important to ask the developer, who is often the building owner, about the age of the building, any renovations and knowledge of the presence of asbestos. In addition, be aware of signs of asbestos, so that the necessary precautions can be taken. For smaller service tasks, the contractor employing the workers who are carrying out the job must register where asbestos or

asbestos-containing material has been used in the parts of the workplace where the work is to be performed.

In the event of any suspicion of asbestos in buildings and structures before 1990, the work must be planned, organised and executed in accordance with the asbestos rules. The asbestos rules will continue to be applicable until further investigations show that asbestos fibres are no longer present in the building. Read more about preliminary studies at asbest-huset.dk.



Notification to the Danish Working Environment Authority

If a material containing asbestos is removed inside buildings, etc., it is necessary to report this to the Working Environment Authority. The same applies to work assessed to only involve short-term and low exposure to asbestos, e.g. demolition of slate plates containing asbestos on roofs that cannot be completely dismantled.

Statutory training and special instruction

Persons working with internal demolition must have proof of having completed the statutory training. In the case of other work where there is a risk of contact with asbestos dust, including cleaning, employees must undergo a special training and instruction process. The employer must be able to document that the employees have undergone a special training and instruction process.

Protocol

The employer must keep a record of employees who have been exposed to asbestos in connection with their work. The record must contain information specifying the nature and duration of the work and the effect of asbestos. The record must be stored for at least 40 years after the cessation of asbestos exposure. In the event of cessation of business, the record must be sent to the Danish Working Environment Authority.

In asbest-huset.dk you can see what a record can look like.

Planning and preparation

The general workplace assessment (WPA) must be supplemented with a chemical risk assessment describing how the special asbestos rules can be complied with. When demolishing asbestos, the chemical risk assessment can be part of the work plan that the employer must prepare for this type of work.

The work plan must be prepared, regardless of whether the demolition work is dusty or not, and must describe in detail how to handle asbestos and asbestos-containing materials in a safe and responsible manner. This includes the use of the necessary dust-free working methods, ventilation, personal protective equipment and the disposal of waste. If a building is demolished, materials containing asbestos must be removed prior to demolition.

The work plan must also include cleaning work in connection with demolition work.

Tools and working methods

- Use working methods and tools that generate as little dust as possible. Carefully remove the asbestos-containing materials so that they are damaged as little as possible. Dust can be prevented by moistening the materials containing asbestos.
- Remove the dust where it develops. If it is necessary to use machines for demolition, choose low-speed mechanical tools with direct extraction mounted on H-vacuum cleaner with exhaust to the open air. If machines are used, the work will in many cases cause asbestos dust to a significant extent, so the work must therefore be carried out under dust-proof screening with locks and vacuum.

Personal protective equipment

- Use respiratory protection if there is a risk of asbestos dust. The respirator must be at least a half mask with P2 filter and must be suitable for removing asbestos dust, tight-fitting and suitable for cleaning. A filter mask may be used for a maximum of 3 hours distributed over a working day. When working for more than 3 hours, use a suitable turbo mask or respiratory protection with an air

supply. Respiratory protection equipment with an air supply must be used for internal demolition. When taking down slate tiles containing asbestos, a turbo mask must be used.

- Respiratory protection with an air supply and turbo mask may be used for a maximum of six hours distributed over a working day. In the case of asbestos demolition work, respiratory protection equipment and turbo masks must not be used for more than four hours per day and rest breaks must be taken no later than after two hours of work. In the case of particularly stressful work, the working hours must be reduced further.
- Use dust-repellent workwear with a hood. The suit should fit close to the neck, wrists and ankles. The hood must be pulled over the respirator so that the suit can be removed without having to remove the respirator. Workwear must be changed frequently and must not be worn during lunch breaks.

Screening and cordoning off



No one other than those carrying out asbestos work may be present at the workplace. The work area must be demarcated and there must be visible signs saying: "Caution, asbestos work. No unauthorised access".

During demolition work where asbestos dust appears to be substantially trapped, the work site must be shielded from the surroundings by means of a tent or similar that is impermeable to dust. The tent must be accessed through an air lock and ventilated to prevent dust spreading to other areas. The screen must not be removed until the main cleaning has taken place.

Waste

Asbestos dust and dusty asbestos-containing waste, such as dust, dirt and filters, must be moistened and then stored and removed in tightly sealed containers. The container must be labelled to indicate that it contains asbestos. Waste containing asbestos that may be

6. CHEMICALS AND DUST

dusty, e.g. soft ceiling and wall plates, must be moistened and covered during storage and transport. Removal must take place as instructed by the municipality.

Cleaning

Effective cleaning of the work site is important. This applies to workplaces where there may be a risk of exposure to asbestos or other materials containing asbestos. Cleaning must take place regularly and so often that there is no risk of dust contamination, either during work or after the end of the work.

Changing rooms, bathrooms and canteens must be cleaned regularly.

Following interior demolition, a deep clean must be performed by vacuuming and then wet cleaning. Dry sweeping is not permitted. Finally, air thoroughly for 24 hours, clean again and ventilate again for 24 hours. An H-marked vacuum cleaner suitable for asbestos must be used for cleaning.

The same personal protective equipment must be used when cleaning as when working.

Hygiene measures

For asbestos work, there must be access to changing rooms and bathrooms with cold and hot water. Workwear and daily clothing must be stored separately. There must also be access to a canteen which must not be used for work purposes. The rooms must be cleaned thoroughly on an ongoing basis.

In the event of dusty asbestos work and the demolition of asbestos, changing rooms and bathrooms must be placed in the immediate vicinity of the workplace. In the case of dusty asbestos work, changing rooms and bathrooms must be fitted out as two changing rooms, a clean and dirty one, where access between them takes place via a shower. For dusty asbestos work, clean thoroughly at all times. Remember instruction on precautions against exposure to asbestos in connection with cleaning.

Personal hygiene

Good personal hygiene is important. Wash your face, forearms and hands before taking breaks in the canteen and going to the toilet – and always at the end of the working day.

In the case of dusty work, take a bath before breaks in the canteen – and always at the end of the working day.

MINERAL WOOL AND OTHER INSULATION MATERIALS

Insulation with mineral wool

Mineral wool (stone or glass wool) is widely used for insulation. When working with mineral wool products, mineral fibres of varying sizes are released. The larger fibres can cause itching and rashes as they cut small scratches in the skin. The fibres can also irritate the eyes. The smaller fibres can block the nose and cause pain in the nose and throat.



Various types of mineral wool insulation have harmful effects on health in dust-generating work, which must be taken into account when choosing products and working methods. As far as possible, choose least dusty product.

If possible, choose standardised, sealed and specially ordered processed products that will reduce cutting.

Choose to insulate from the outside and from above and before constructions are closed, e.g. attics and loft spaces. Avoid insulating above head height. Prepare the structure for standard insulation materials.

The supplier and contractor must prepare instructions for use with information about health risks and which safety measures must be taken in relation to the selected product.

Working with old mineral wool

According to the EU regulation on classification, labelling and packaging (CLP), fibres of old mineral wool are classified as potentially carcinogenic - even if there is no scientific agreement on this. However, you should generally protect yourself effectively against fibres and dust if you need to remove or move the wool.

Wear suitable respiratory protection (at least half mask with P2 filter). Wear gloves, safety glasses and dust-repellent workwear. Clothing must not be separated at the waist, and it must fit snugly around the wrists, ankles and neck and have no pockets or holes. Any head covering must have a peak.

Ceilings with roofing of asbestos cement tiles

For all types of work on loft spaces where the roof above consists of asbestos cement tiles, determine whether there may be asbestos fibres present in the room and in the insulation material. If so, the work will be governed by the Asbestos Order, which includes special requirements for training, protective equipment and welfare measures.

If the work consists of minor repairs to installations and pipe systems in attics where no intervention is made on the building elements containing asbestos and the attic or loft space has been cleaned of asbestos dust, this does not constitute asbestos work. The chemical risk assessment must assess which safety measures are necessary to protect against exposure to asbestos dust during the specific task.

Insulation with new insulation materials

New insulation can also be paper wool, flax, perlite, wood fibres, etc. Plan the work process in a way that minimises dust emissions. See section on "insulation with mineral wool insulation".

Especially dusty work

Particularly dusty work can be:

- demolition of old insulation material
- insulation above head height - depending on the insulation material
- re-insulation in confined spaces, such as in the sight rooms, technical hallways, basements and other confined spaces with poor ventilation - depending on the insulation material
- supply or application of granulate products

Work must be planned so that it does not unnecessarily affect other work in the vicinity. With especially dusty work, more stringent measures apply. As far as possible, when it occurs, all contamination at the site must be removed. This will normally be done with ventilation.

Employees must have access to changing rooms with separate storage of footwear and workwear. It must also be possible to take a hot shower.

Cleaning

Cleaning must be done so that it creates as little dust as possible, e.g. by vacuuming or washing. Floors must not be dry-swept or cleaned with compressed air. Where possible, floors should be kept damp during work in order to restrict the amount of dust given off.

QUARTZ DUST

A large number of construction materials are made from sand, clay, granite, flint, quartz powder (silica), etc. and contain quartz (crystalline silicon dioxide). The same applies to some types of paint, filler, glue, etc.

Quartz dust is created when e.g. flint, sandstone, granite and concrete are worked, or during sandblasting. Some of the dust comprises small particles which go right down into the smallest parts of the lungs when inhaled. This respirable dust, as it is known, irritates the mucous membranes and accumulates in the lungs of the person inhaling it.

6. CHEMICALS AND DUST



This carries a risk of the development of silicosis (chalicosis) and lung cancer. These illnesses manifest themselves through coughing and increasing shortness of breath. The illnesses can be diagnosed through impaired pulmonary function and pulmonary X-rays.

Safety arrangements

It is possible to restrict the development of quartz dust as follows:

- Use the least dusty work processes, e.g. cutting instead of cutting and chopping, and use slow moving tools.
- Use tools connected to a dust class H vacuum cleaner - dust extractor when working with striking, drilling and cutting tools.
- Make sure to sprinkle water when dust cannot be sucked away.
- Set aside time for regular cleaning - and do it.
- Clean by vacuuming or wet sweeping - not dry sweeping. Vacuum cleaners must be fitted with suitable filters, i.e. filters that can retain dust that can be inhaled. Use a class H vacuum cleaner. Use personal protective equipment if necessary. Respiratory protection must be at least a half mask with at least P2 filter.

WOOD DUST

Wood dust is created when wood is worked. Wood dust can dry out the skin and mucous membranes and irritate the airways and mucous membranes. Wood dust can cause nasal cancer and can cause allergies to varying degrees. Dust from hardwood is more dangerous than dust from softwood.



Safety arrangements

At fixed workplaces there must be extraction (process ventilation) and there must not be recirculation of the air. The same applies to the processing of hardwood and large quantities of softwood on construction sites and alternating workplaces.

Cleaning must be done with a vacuum cleaner. The vacuum cleaner must be fitted with a filter suitable for preventing the escape of wood dust. It must be a class H vacuum cleaner.

WELDING AND CUTTING SMOKE

Smoke and dust from metalworking contains gases and particles from heavy metals, among other things, which together can cause chronic bronchitis, asthma and cancer of the respiratory tract. This may happen if the contamination is not removed effectively. Air contamination which is particularly hazardous to health may occur if electrodes, base materials or coatings on base materials contain substances such as zinc, copper, lead, cadmium or chromium.



Use suitable ventilation and extraction systems to remove welding smoke and grinding dust. Use a portable system if it is not possible to establish a central ventilation system. The ventilation system's exhaust vent must lead out to the open air and must be equipped with a control device showing whether it is functioning effectively. Mechanical process ventilation must generally also be used for outdoor work, e.g. when welding district heating pipes in excavations.

In many cases, it may be necessary to use suitable respiratory protection. Suitable respiratory protection equipment will be an air-supplied visor with overpressure, but may, depending on welding and cutting methods, also include a turbo filter mask with a suitable filter. However, this requires the manufacturer to indicate that the turbo filter mask with filter is suitable for the welding method and the material being welded in. This normally requires a combination filter.

6. CHEMICALS AND DUST

When welding at height, an assessment must be made to determine how both the welding method and the actual weather conditions may affect the specific measures to be taken.

Welding and cutting of all forms of metal and associated grinding may be carried out only by trained persons.

FLY ASH

Fly ash is used as a filler in connection with roadbuilding, as well as in cement, concrete and gas concrete.

Fly ash consists of fine-grain particles which are separated from the flue gases from coal-fired power plants. Contact with the skin and mucous membranes may cause acute irritation. Allergies may also occur with long-term contact.

Minors under 18 must not work with or come into contact with fly ash. All work with fly ash must be arranged so that it produces as little dust as possible and there is as little exposure to it as possible. This can be done, for example, by humidifying while working. The cabs of construction machinery must be designed so that fly ash cannot enter the cabin, e.g. air supply must pass an effective particulate filter.

In the event of contact with fly ash, it is important to use personal protective equipment such as gloves, dust-repellent workwear, eye protection and suitable respiratory protection, e.g. turbo equipment with a hood and particle filter.

CEMENT

The calcium compounds in cement and mortar products irritate the skin and mucous membranes. Water-soluble chromate in cement may cause eczema on contact with the skin.

The use of cement and non-cured cement products containing more than 2 mg of water-soluble chromate per kg of dry cement is prohibited.

If additives (iron sulphate) are used to reduce the chromate content in cement and products containing cement, the packaging must be labelled with clearly legible information on:

- Content of water-soluble chromate
- Packaging date
- Storage conditions
- Storage period (packed cement 12 months and 2 months after plastic packaging has been broken)

When using cement, a chemical risk assessment must be carried out.

LEAD

Lead compounds were formerly used in products such as paint and as flashing.



There may be a risk of harmful effects on health when renovating and demolishing lead and leaded materials, e.g. when drilling holes in existing walls, grinding walls, removing flashing or demolition work. This is especially relevant when scraping, burning and cutting materials covered with leaded paint.

Exposure to lead for long periods of time can damage the nervous system, brain, kidneys and gastrointestinal tract. Lead may impair the ability to have children for both men and women and cause foetal harm. Some lead compounds are also carcinogenic.

Minors under 18 years of age, pregnant or nursing women must not work where they are at risk of being exposed to lead. Work with lead and leaded materials is considered to be particularly hazardous work.

Paint containing lead

The employer must monitor the lead content of all affected employees in the blood if there is a risk of exposure to lead. Blood samples should be taken at the start of work or no later than 15 days after and again

6. CHEMICALS AND DUST

every 6 months. The blood tests must show whether the measures are working and whether personal hygiene is sufficient. If the blood tests show elevated levels of lead, the measures and personal hygiene should be reassessed. If the blood test results are above the threshold, the employee in question must undergo a medical examination immediately.

At the values shown below, the following measures must be taken:

- Over 20 µg lead/100 ml blood: The amount of lead contamination is reduced and the precautions are inspected/adjusted.
- Over 40 µg lead/100 ml blood: The employer must ensure that the employee is immediately examined for health risks.
- Over 70 µg lead/100 ml blood: The doctor must advise the employee not to continue to work with lead.

Analyses of the amount of lead in the blood must be carried out at the employer's request, e.g. by a privately authorised working environment advisor or a private clinic/hospital at the employer's expense. In general, GPs do not conduct or refer for this type of analysis.

At construction sites and changing workplaces, dust measurements can primarily be used to ensure that final cleaning has been thorough enough. If the measurement shows that there is no lead, the work area can be transferred to the next stage of the construction project.

Personal hygiene

When working with lead, it is important to maintain good personal hygiene, as lead can easily be transferred from the hands to the mouth when eating or smoking. It is therefore very important to wash your hands, underarms and face thoroughly before drinking, eating or smoking. In the case of very dusty lead work, a bath or shower should be taken before breaks and always at the end of the working day.

Planning and preparation

The general workplace assessment (WPA) must be supplemented with a chemical risk assessment for how you handle lead on the construction site. The special assessment can be a work plan that describes in detail how to handle lead safely and securely. See section on "chemical risk assessment".

The construction site Health and Safety Plan (HSP) must also state where lead is to be found.

Work must be planned so that any spread of lead is avoided. If the work is very dusty, it may be necessary to access the work area via a sluice. Depending on the layout of the construction site, it may be necessary to locate washing and bathing facilities so that they are immediately accessible from the work site.

When leaving the workplace, it must be ensured that the rest of the construction site is not contaminated with lead. It may therefore be necessary to clean tools, mobile phones, etc., before they are taken out of the workplace. In the case of particularly dusty work, it may be necessary to regularly clean the work site.

Depending on the nature of the work, it may be necessary to use personal protective equipment. These may include gloves, dust-proof overalls, goggles and respiratory protection, which must be at least a half mask with P3 filter if there is a risk of inhaling very fine dust (respirable dust). Remember not to wear dirty protective equipment when leaving the work area. Access to the work area shall be restricted and lead warning signs posted.

Safety arrangements

Effective measures must be taken to prevent the development of lead dust or vapours containing lead. If lead dust is present, it must be removed by extraction from the development site, e.g. by drilling holes or grinding walls. Personnel may need to wear suitable respiratory protection if there is a risk of inhaling the dust. If there is a risk of skin contact, personnel must use personal protective equipment, such as gloves and work clothes, which must be dust-repellent. This garment must be stored separately from other clothing.

6. CHEMICALS AND DUST

Personal protective equipment, including workwear, must not be taken home. If it needs to be washed, this must take place at the work site or at a laundry with special equipment for the purpose. The clothing must be transported in closed containers.

Welfare and health measures

Bathrooms with wash basins and showers with hot and cold water must be available adjoining the changing rooms. There must be two lockers per person so that workwear and private clothing can be kept separate.

There must also be access to canteens that must not be used for work purposes. It must be ensured that dining rooms are not contaminated with lead, and dirty protective equipment must therefore not be worn. It is therefore not permitted to eat, drink or smoke in the workplace or to store drinks, food and tobacco products at the workplace.

Workplaces, changing rooms, bathrooms and canteens must be regularly and effectively cleaned. Remember to instruct the staff who will be cleaning these facilities.

Waste

Waste containing lead must be collected and stored safely at the construction site until it can be disposed of in closed containers or similar. Disposal must take place in accordance with local authority instructions.

SOIL CONTAMINATED WITH OIL AND CHEMICALS



Working with soil contaminated with chemicals may be hazardous to health. Without knowing the nature and extent of the contamination, it is impossible to determine the health hazard involved in the work. The employer must prepare a special plan for the work, and the developer must do the same in relation to coordination and demarcation.

Contaminated soil occurs particularly in connection with excavation work for the installation of cables and pipes, water and excavation of soil from factory sites, former service stations, etc.

Therefore, it is necessary to examine at an early stage in project planning whether the ground or any part thereof is contaminated with chemicals which are hazardous to health. If so, it is important to find out what chemicals are involved and the extent of the contamination. If you encounter an unknown contaminant, the work must be stopped and the contamination must be investigated.

When planning, try to anticipate accident and health hazards and describe how measures can be taken to avoid them.

If an unknown contaminant is encountered, for example during excavation work, you must stop work and call in a special expert. The Working Environment Authority and the local environmental authorities must also be notified.

Safety arrangements

The employer must do everything technically possible to avoid employees being affected by the contaminated soil. These may include, for example:

- Positive pressure ventilation with fresh air to the driver's cab
- Sprinkling of dusty work
- Establishment of membranes and pumps so that vapours, liquids, etc. do not penetrate the excavation
- Execution of the work as far as possible above the excavation
- Limitation of access to the contaminated area.

If it is not possible to carry out the work safely in any other way, employees must use personal protective equipment. This may include fresh air respiratory protection equipment, protective clothing, protective gloves and oil-repellent and chemical-resistant safety rubber boots. For machine operators and drivers, it may be necessary to use protective clothing, protective rubber boots, gloves and suitable respiratory protection.

Welfare and health measures

There must be access to canteens, changing rooms with a locker for workwear and a locker for everyday clothes, washbasins, bathrooms with shower and toilet in the immediate vicinity of the workplace.

The canteen must be kept free of the effects of contamination, and dirty protective equipment must not be worn.

Personal hygiene is important. It is particularly important to ensure that contaminated skin is cleaned thoroughly. Wash your face, hands and forearms before taking a break in the canteen, before going to the toilet and always at the end of the working day. With dusty work, have a bath or shower before breaks and always at the end of the working day.

Changing rooms, bathrooms and canteens must be cleaned regularly.

PCBS



PCBs (Polychlorinated Biphenyls) is an abbreviation for a group of chemical substances. With prolonged exposure, PCBs accumulate in the body. PCBs are generally considered to be carcinogenic. PCBs can also have foetal-damaging effects and impair fertility.

PCBs were used in elastic sealants from 1950-1976 in all types of buildings and as sealing adhesive in double glazing from 1967-1973. PCBs can also be found in floor varnish, paint, etc.

PCBs penetrate easily from glue or sealant into the surrounding woodwork or concrete, and also easily evaporate into the indoor climate. PCBs from the indoor climate can be absorbed by wall paint, lacquered surfaces, furniture and plastic. Consequently, one time PCBs, from a sealed joint, for example, can contaminate other building parts and fittings.

The use of PCBs was extensive. The Danish Health and Medicines Authority has therefore prepared some action values for the concentration of PCBs in the indoor climate in buildings with a description of

recommended measures for the various values. The Danish Working Environment Authority has also drawn up guidelines for how much PCB there may be in the indoor climate at workplaces, before the employer will be required to reduce the concentration of PCB in the air.

Planning and preparation

The general workplace assessment (WPA) must be supplemented with a chemical risk assessment on how to handle PCBs on the construction site. This special assessment can be a work plan that describes in detail how to handle PCBs safely and securely. The construction site Health and Safety Plan (HSP) must also state where PCBs may be found. See more about this in the section on "chemical risk assessment".

Work must be planned to avoid any spread of PCBs. Firstly, avoid spreading dust, and secondly, note that PCBs evaporate when they are heated, e.g. when using high-speed tools. If the work is very dusty or the PCB concentrations are very high, access to the work area via a sluice is necessary.

Wash basins with hot and cold water must be available in the immediate vicinity of the workplace. For renovation work, two changing rooms must be established in the immediate vicinity of the workplace. See more in the section on welfare measures.

When leaving the work site, it must be ensured that the site is free from material containing PCB, so that the rest of the construction site is not contaminated. Tools, mobile phones, etc. must also be cleaned before they are removed from the workplace. With particularly dusty work, the work site must be cleaned regularly.

When working with PCBs, always use personal protective equipment. These may include gloves made of nitrile, dust-proof overalls, protective goggles and respiratory protection, which must be at least a half mask with P3 during cold work or A2/P3 filter during work where the sealant is mechanically processed. Remember not to wear dirty protective equipment when leaving the work area.

6. CHEMICALS AND DUST

Access to the work area must be restricted and a PCB warning sign must be displayed.

Working with PCBs is considered to be particularly hazardous work. Minors under 18 years of age and pregnant and nursing women must not work where they are at risk of being exposed to PCB. However, young people who have reached the age of 15 may undertake work with a risk of exposure to PCB if the work is included as a necessary part of vocational training.

Welfare and health measures

Bathrooms with wash basins and showers with hot and cold water must always be accessible in connection with changing rooms. There must be two lockers per person so that workwear and private clothing can be kept separate. There must also be access to canteens that should not be used for work purposes. It must be ensured that canteens are not contaminated with PCBs, and dirty protective equipment must therefore not be worn in the canteen. It is therefore always recommended to wear coveralls.

In the case of particularly high PCB concentrations and in the case of very dusty work, such as renovation work, changing rooms and bathrooms must be established in the immediate vicinity of the workplace. Changing rooms and bathrooms must be established as two changing rooms; one clean and one dirty, where access between them takes place via shower rooms. Changing rooms, bathrooms and canteens must be cleaned regularly. Instruction must be given in the safe handling of PCB in connection with cleaning.

Waste

Waste containing PCB must be collected and stored safely at the construction site until it can be disposed of in closed containers or similar. Disposal must take place in accordance with local authority instructions.

Clearance projects

If a clearance project is taking place in which all material contaminated with PCB is to be removed, there are a few special rules. The work site must be screened off to the necessary extent, and negative pressure must be established in the work area. In addition, special tools must be used with extraction and dust filters.

With renovation work, the following personal protective equipment should normally be used:

- Respiratory protection equipment with P3 filter. For dusty work, use respiratory protection equipment with an A2P3 filter or respiratory protection with an air supply
- Gloves in a material that protects against PCB, e.g. butyl rubber, neoprene, viton or 4H (PE/EVAL)
- Full-cover overall, class 4/5

CHLORINATED PARAFFINS

Chlorinated paraffins were used from 1950 –2012 as:

- softeners in sealants around windows and doors
- cutting oils
- anti corrosive paint and primer.



However, in the vast majority of buildings, it is mainly used as a softener in sealants on the outside fabric of the building.

When handling chlorinated paraffins, use the same precautions as when working with PCB. Gloves must be made from a material that protects against chlorinated paraffins.

BIOLOGICAL EFFECTS

You may be exposed to biological effects in a number of work processes. These include:

- Working on or connecting sewers
- Excreta in relation to renovation work
- Sanitisation in connection with mould infestation.

Drains and waste water

Vomiting or diarrhoea may result from the inhalation of aerosols or following skin contact with waste water. Unnecessary skin contact with waste water can be avoided by wearing disposable suits, gloves or special work clothes. This must not be taken home and washed.

In connection with work in wells, pipes and structures with waste water, there may be a risk of lack of oxygen and exposure to toxic fumes and microorganisms. The following types of respiratory protection equipment must therefore be used:

- If there is a risk of inhaling aerosols with microorganisms, a P3 mask must be used.
- If there is a risk of exposure to toxic gases or vapours, the P3 mask must be supplemented with a gas filter - depending on the type of gases that can be exposed to.
- In oxygen-deficient environments, respiratory protection with an air supply must always be used.
- In the case of complex air pollution and several different types of contamination, respiratory protection with an air supply may be necessary depending on a specific assessment.

If your work involves working with waste water or sewage sludge, you must be vaccinated against tetanus, Hepatitis A and polio.

For other work, e.g. demolition of downpipes, etc., you should be vaccinated against tetanus.

There may be germs in both dry dust from sludge and aerosols from high-pressure washing, which employees must be protected against.

Welfare and health measures

Welfare measures must be established with access to changing rooms and bathrooms with cold and hot water. Two separate changing rooms must be established, one for footwear, etc. and one for workwear. The rooms must be located in such a way that traffic between them can only take place through a bathroom with hot and cold water.

Bathing facilities with changing rooms must be lockable if women and men use the same mobile workmen's huts.

There must be access to two cupboards, one for clean and one for dirty clothes. There must also be access to a canteen which should not be used for work purposes. The rooms must be cleaned thoroughly on an ongoing basis.

The changing rooms must be well-ventilated and the size adapted to the number of users.

Employees are obliged to use the designated bathrooms before lunch break and always at the end of the working day in order to avoid contagion.

Cleaning must be performed regularly at the workplace, in changing rooms, bathrooms and canteens at least once a day.

Excreta

Dust from animal excrement may contain endotoxins which are harmful to health. Therefore, preliminary investigations must be carried out during renovation work, including in basements and in lofts and attics.

A preliminary examination may show whether there is any significant health-affecting residue from either animals or humans. This may include pigeon growth, rat excrement or hypodermic needles. Work must be planned so that harmful residue is removed before work commences. You must use personal protective equipment such as respiratory protection, disposable overalls and gloves.

6. CHEMICALS AND DUST

There may be a risk of Weil's disease when working with sewers or following sudden cloudbursts where water from sewers has risen up into the basements.

The symptoms of Weil's disease are, especially at first, often uncharacteristic and may resemble influenza. High fever, headache, muscle pain (especially in the calf and lower back) and bloodshot eyes are common. You can protect yourself with waterproof clothing and glasses when working in basements or other flooded areas where there is sewage. Weil's disease can be treated with antibiotics.

Dealing with mould



You may encounter mould in structures during renovation work. Mould can be found in private buildings, public institutions, schools, etc. Some varieties of mould give off toxic spores and may cause health problems. It is often the case that you cannot see with the naked eye whether or not a mould present is harmful to health, so it is necessary always to handle mould with care.

When removing mould, it is necessary to protect yourself and your surroundings against effects which are harmful to health. At the same time, it is necessary to ensure that infected dust and mould spores are not spread. Be aware that remaining in infected rooms may pose a risk. Any users, e.g. residents, should therefore also be informed of this.

Avoid touching mould with bare hands. Use a class H vacuum cleaner to avoid inhaling spores and dust, as well as getting fungal spores or dust in the eyes. The machine must be disinfected after use and the filter replaced or the machine must be sealed and only used for mould. If the machine is left for a longer period of time, it must be cleaned and the filters replaced.

You must use a vacuum cleaner with a microfilter, e.g. a HEPA filter.

- Tight-fitting gloves and footwear
- Glasses
- Dustproof coverall, possibly as a disposable suit
- Turbo mask with A2/P3 filter or, if applicable, respiratory protection with an air supply.

LIFTING AND WORKING POSITIONS

The body is subjected to physical strain when working. The strain can lead to musculoskeletal problems (MSP). MSP is a generic term for pain, stiffness or tenderness in the joints, ligaments, tendons, muscles and bones of the body, as well as related vessels and nerve supply. Loads can lead to actual industrial injuries.

Industrial injuries and illnesses

An industrial injury covers two different concepts:

- Industrial accidents
- Occupational illness

Industrial accidents

An accident is a physical or mental injury that occurs after an incident or accident that has occurred suddenly. According to the Danish Industrial Injury Insurance Act, this may also be an injury that occurs after an impact of no more than five days.

Occupational illness

An occupational illness is an illness that is brought on by work or by working conditions. The illness may last for a shorter or longer period of time.

Loads that can lead to occupational injuries typically arise from:

- Heavy lifting, pulling, pushing and carrying
- Inappropriate working positions
- Monotonous repetitive work (EGA)
- Unilateral burdensome work (EBA)
- Stationary work, e.g. office work and construction machinery.

The typical injuries and inconveniences that can occur are:

- Stretches or pulled muscles

7. LIFTING AND WORKING POSITIONS

- Slipped discs
- Back strain
- Sprains
- Arthritis
- Blood circulation issues
- Myoses
- Tendonitis.

External factors such as cold, draughts and vibrations often reinforce the aforementioned effects.

Similarly, it is not conducive to work if tools and workplace layout do not allow the work to be carried out in the best possible way.

Planning the work correctly can minimise the risk of musculoskeletal disorders. These include in particular:

- that the workplace must be equipped with good and appropriate access and transport routes so technical aids for the transport and handling of materials can be used unhindered - and that lifting and carrying are avoided.
- that the workplace must be designed to suit each employee.
- that machines and tools are suitable for both the work and the person performing the work.
- using ergonomically designed tools, tools and technical aids. This enhances safety and reduces injury. Find out more at www.bygergo.dk.

It is also an advantage to be fit and healthy. Fitness, flexibility and muscle strength prevent overloads and aid a more rapid recovery from musculoskeletal problems.

Lifting and carrying

Lifting involves handling an object so that it is entirely or partly not resting on the ground. When carrying, lift the load while walking for a distance of more than approx. 2 m. Manual lifting means that one or more persons lift an object - without the use of a technical aid.

To avoid musculoskeletal problems, take especial care, for example, when lifting:

- Below knee height
- Above shoulder height
- From the side
- With one hand
- In confined spaces
- On uneven and slippery surfaces
- On ladders and stairs
- When the load is bulky or difficult to get a grip on.

Always try to use suitable technical aids when handling loads instead of lifting and carrying them.

If this is not possible, the load must be lifted and carried as close as possible to the body. Make sure that you get a good grip of the load with both hands. Also choose a good working position for lifting, and make sure you have plenty of visibility and a secure surface to work on.

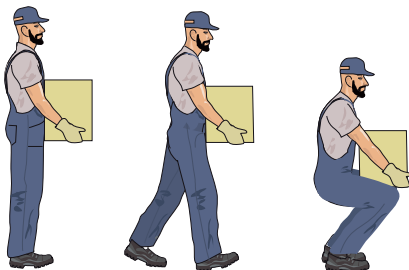

Pulling and pushingk

Using hand trucks, wheelbarrows and brick trolleys make it easier to move tools and materials around. But pushing and pulling where the whole body is used can require a lot of physical effort. Especially on slopes, uneven ground, confined spaces or repeated stops/starts, etc. Poor maintenance of the hub and wheels on the equipment helps to increase resistance.

Your body may be exposed to sudden strain when pushing or pulling objects over a curb, or unexpected strong movement.

Poor visibility, slippery surfaces or skidding increase the risk of sudden major strain.

Use a crane or self-propelled aid where possible and especially if the increase is too large or if the surface is too uneven or too greasy.

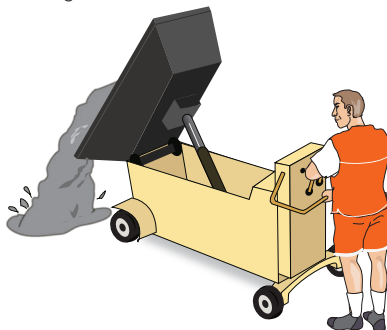

Use a crane or a self-propelled aid if the slope is too steep or if the ground is too uneven or slippery. Make sure, for example, that you select the most suitable transport trolley and that it is properly maintained, well lubricated, smooth-running and cleaned. Choose means of transport with large wheel diameters, not too narrow tyres and good wheel bearings. Wheels and tires must match the ground surface.

The surface must be smooth and level to move on, there must be no objects in the way, there must be good lighting and there must be no holes. Immediate enforcement notices are issued by making a decision on the spot.

Also avoid changes of level or other obstacles. Handles should be approximately elbow height or slightly lower.

Assessment of lifting

Several things affect the extent to which the back is placed under strain when lifting and carrying.



Whether lifting is considered to be heavy and hence harmful to health is dependent in the first instance on an assessment of the weight of the load and how far away it is from the body.

The red, yellow and green area in the displayed assessment model shows weight limits for two different reach distances. Lifting close to the body is rarely possible in practice unless slings are used, for example, and so this is not included in the assessment diagram.

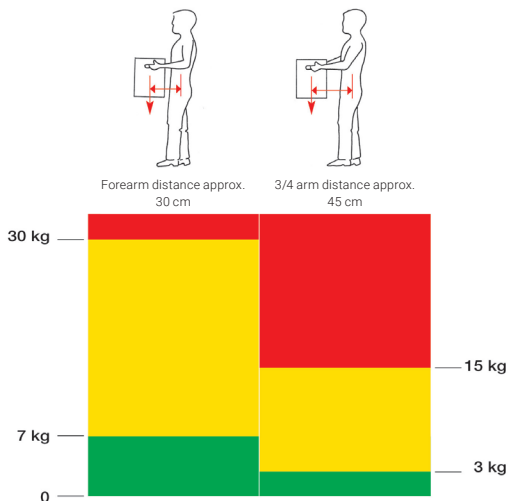

7. LIFTING AND WORKING POSITIONS

Green area:

If lifting takes place in the green area in the assessment diagram, lifting will not in principle be regarded as harmful to health.

Red area:

Conversely, lifting in the red area in the assessment diagram will always be regarded as harmful to health and may present an acute risk of back injury. Therefore, arrangements must be put in place promptly to counter the risk.

Yellow area:

Lifting in the yellow area can also be harmful to health if other factors besides weight and reach distance make lifting worse.

Therefore, lifting in the yellow area must always be considered in greater detail. Before lifting, check whether the following aggravating factors may present problems:

- Bending forwards
- Twisting or asymmetrical strain on the back
- Raised arms.

If at least one of the main aggravating factors is not present in the yellow area, the lift is not normally considered harmful to health. If at least one of the above aggravating factors is present, the lifting frequency and duration of the lift must also be included in the assessment, as shown below.

This assessment is carried out in accordance with the table below:

Duration \ Lifting frequency	Short duration 2.5 - 4 hours per week	Moderate duration 4 - 7.5 hours per week	Long duration over 7.5 hours per week
Low lifting frequency (2 - 12 lifts per hour)			
Moderate lifting frequency (12-120 lifts per hour)			
High lifting frequency (over 120 lifts per hour)			



If the frequency and duration are in this range, lifting in the yellow range of the lifting diagram is not normally considered to be harmful to health.



If the frequency and duration are in this range, lifting in the top 1/3 of the yellow range of the lifting diagram is considered problematic, and the Danish Working Environment Authority may issue enforcement notices following a concrete assessment.



If the frequency and duration are in this range, lifting in the top 1/2 of the yellow range of the lifting diagram is considered problematic, and the Danish Working Environment Authority may issue enforcement notices following a concrete assessment.



If the frequency and duration are in this range, lifting in the top 2/3 of the yellow range of the lifting diagram is considered problematic, and the Danish Working Environment Authority may issue enforcement notices following a concrete assessment.



If the frequency and duration are in this range, lifting in the yellow range of the lifting diagram is considered problematic, and the Working Environment Authority may issue enforcement notices following a specific assessment.

Carrying

When you lift or carry an object for a long time, the muscles will be tense all the time. If you walk at the same time, your back will be twisted and under an uneven strain.

If you trip, slip or bump into something while you are carrying something, your body is subject to major strain. If you stumble, slip or bump anything while carrying, your body is subjected to a lot of strain.

Repeated minor injuries increase the risk of longer-term problems. Avoid carrying anything other than small tools up ladders and stairs as this increases the risk of acute injury and accidents involving falls.

If it is not possible to use suitable technical aids to transport loads horizontally or vertically, the following must be taken into account when carrying loads:

- When carrying close to the body, the load must not exceed 20 kg and the distance must not exceed 20 m.
- One step is equated to one metre. If the centre of gravity of the load is at forearm's distance or at 3/4 arm's distance, the maximum load weight is reduced to 12 kg and 6 kg respectively.

Prevention of injury resulting from lifting and carrying

Planning, layout of the workplace and the use of technical aids and proper working techniques can help to prevent overloading the body.

- Technical aids must be used for transporting and installing heavy and awkward loads, such as doors, windows, radiators, washbasins, locks, rafters, roofing panels, plasterboards, shuttering elements, curbstones, concrete elements and element supports, etc.
- Some handling can be reduced by delivering correctly packaged materials at the right time and place.
- Lorry-mounted cranes should be used when loading and unloading heavy implements and materials.
- Delivery and storage must take place as close to the place of use as possible and so that the items can be transported/installed easily with the chosen technical aid.

- Plasterboards, concrete elements and other building components must always be supplied with a Danish language user manual describing the component's weight and how it is handled and set up/ installed in a completely safe manner in terms of health and safety.
- In connection with the work, there must be instructions for use in Danish and other languages that the employees understand, describing how to set up, operate and maintain the technical auxiliary equipment.
- Cranes, trucks, telescopic loaders, plaster trolleys and sack trucks etc. are used as often as possible instead of manually carrying them. Plasterboard, etc. can be supplied to the work site, packed in the order in which it is to be used and cut to size, which may save a certain amount of handling.
- There is equipment for loading onto floors, trolleys and work tables with vacuum lifts fitted for installation, etc.
- Lifting below knee height and above shoulder height can be avoided by placing the items on trestles, work benches/trolleys, at a suitable height from the start.



Lifting and carrying techniques

Do not lift if you are in doubt as to whether you can cope with a load. Using the correct lifting and carrying techniques reduces the risk of injury.

- Approach the load. Stand facing the load with legs spread apart for lifting.
- Assess the weight of the load and position of the centre of gravity.
- Ensure a good grip on the load.

7. LIFTING AND WORKING POSITIONS

- Bend your knee and hip joints and keep your back straight and stretch your back and abdominal muscles.
- Lift the load gently by stretching the knee and hip joints.
- Hold the load against your body with your elbows slightly bent.
- Lift and carry the load symmetrically, i.e. centrally in front of the body or evenly distributed in both hands.
- Hold your back straight and turn your feet.
- When laying down the load, use the same movements in reverse order.

The following rules also apply:

- the surface must be smooth and stable and footwear must be flexible and firm;
- the transport route should be clear, well lit and as level as possible. It must not be slippery;
- the load or parts of it must not fall down and hit the carrier or others.

Multi-person lift

There may be unexpected loads that require several people to lift together, e.g. if not everyone lifts or releases at the same time or if one person loses their grip during the lift.

The centre of gravity of the load, individual differences between the people lifting together and differences in working technique also affect how much the individual may be affected during lifting.

Where several people lift together, the load can vary. For example, the weight of the load for two-person lifting should not be more than approx. 70% of what the individual is otherwise able to lift.

Two- or multi-person lifts cannot replace the use of suitable technical aids.

Lifting close to the body

This means that two people - close to the body and under otherwise fully optimal conditions - may not lift 100 kg together but at most, 70 kg. However, lifting close to the body is rarely possible in practice.

Lifting at forearm distance, approx. 30 cm from the body

Two persons must lift a maximum of 42 kg.

$\frac{3}{4}$ arm distance, around 45 cm from the body

Two persons must only lift a maximum of 21 kg.

Two-person lift/carry

If a lift involves carrying further than 2 m, a maximum of 12 kg may be lifted at the lower arm distance and 6 kg at the $\frac{3}{4}$ arm distance.

Carrying more than 20 m is not considered safe. If it is done up or down stairs, each step is counted as 1 m.

There are no definite weight limits for multi-person carrying up to 20 m, but when the risk factor of two people working together is taken into account, a reasonable estimate will be a total weight of 16 kg (2 x 8 kg at forearm distance) and a total weight of 8 kg ($\frac{3}{4}$ arm distance), provided that the transport route is level, tidy and well-lit.

WORKING POSITIONS

When the back or neck becomes twisted or bent, these are stressful working positions.

Working while lying down, crouching or kneeling and working above shoulder height are regarded as stressful work.

Stressful working positions are often caused by:

- Poor planning or inadequate planning
- Poorly designed workplaces

7. LIFTING AND WORKING POSITIONS

- For low or high work area, x when working with floors, walls and panels, mounting of electrical and plumbing installations, ventilation ducts, etc.
- Poorly designed tools
- Incorrectly designed work equipment (in relation to task and person).

Poor space is often the cause of awkward and stressful working postures.

Avoid or reduce fixed work, i.e. work in a specific working position over a long period of time. When working in a set position, the same muscles are under a static load for a long time, which results in muscle fatigue and hence a greater risk of injury.

The longer and more often you are exposed to stressful working positions, the greater the risk of injury and difficulty. Quick, forceful movements increase the strain.

Work carried out horizontally or in a kneeling position



Workplace location and space conditions have a major impact on strain on back, neck, arms and knees. For example, when there is too little space at height, so that work must be carried out in lying and kneeling positions. Typical examples are work with insulation in the eaves of a building, joint and insulation work on a narrow pitched roof, plastering under an overhang or renovation of pipe and cable harnesses in existing crawl spaces.

Lying and kneeling working positions should be avoided by anticipating them in planning. For example, you can choose a type of roof tile that does not need to be underlined or sealed, and you can establish engineering passages with a minimum clearance of 190 cm and a clearance width of 60 cm.

In existing crawl spaces, lying and kneeling working positions can be avoided or minimised by method substitution, i.e. pipes and pipes can be routed around.

Crawl space height	Maximum working hours distributed over one day	Factors which may further limit the daily maximum working hours
Between 60 - 90 cm	1 hour	<ul style="list-style-type: none"> • Use of personal protective equipment which may, for example, limit free height when standing • Particularly stressful working positions or access positions • Psychologically harmful working conditions • Personal conditions, e.g. health and weight
Between 90 - 120 cm	2 hours	
Over 120 cm	4 hours	
The actual standing height of the person (s) performing the task in the crawl space	Ordinary working day length	

Always try to assemble and finish as much as possible under good working conditions above ground level so that only the last joints have to be made in the crawl space. Shorter working days, supplemented with breaks and different work, help to reduce the risk of injury and harm. This will alleviate some of the strain on your body. Use a soft surface or alternatively kneepads.

Kneeling work should be limited, e.g. by using a stool instead. The employer must provide knee protectors or kneepads if longer-term kneeling work is unavoidable. Take care to ensure that the knee protectors do not stop the circulation in your legs.



To avoid poor working postures, the workplace should be adapted to the task and ergonomically designed tools used. Also, regularly switch between different working positions and movements. The work will then be distributed between different muscles. To avoid work below a mid-thigh height and above shoulder height, set up the work area according to the task or use height adjustable equipment. If this is not

7. LIFTING AND WORKING POSITIONS

possible, make sure to switch between different tasks and take breaks regularly.

Floor laying, fitting ventilation ducts, various forms of electrical work and painting are all typical tasks where this may be necessary.

Work site layout

Ensure that you can stand and walk upright, that there is room for appropriate working positions and movements, and that it is possible to use good working techniques when the workplace is set up.

Working height is dependent upon the nature of the work and the height of the individual doing it. Workbenches, benches, trestles, etc. should be adjustable. If the work site is to be organised to suit several people or for a range of tasks, it should be possible to adjust the working height easily without using tools.

When selecting a working height, elbow height is taken as a starting point for both work carried out standing and work carried out sitting.

Use adjustable work platforms, work lifts, pillar scaffolding or similar when working at an inappropriate working height. This helps to reduce the strain on the arms and back.

Distance

Work aids and tools must be positioned in such a manner as to allow work movements to take place close to your body. Scaffolding, work platforms, etc. should be set up as close as possible to brickwork, façades, etc.

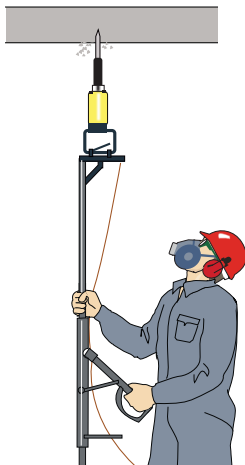

Ambulatory work

The surface must be even, firm, tidy and well lit if ambulatory work is to be carried out. Also avoid level differences, particularly when tools and materials are transported. Tools and means of transport must be long or tall enough to allow personnel to work standing upright. Footwear must have good shock absorption, fit and quality, as they are used as personal protective equipment throughout the working day.

Make sure that there is as little lifting and carrying as possible when transporting materials and tools. This can be achieved by using suitable technical aids.

Monotonous work that places a strain on your body

This is monotonous work when the work is carried out in fixed working positions or where, for example, one arm or leg becomes particularly stressed. Static holding and carrying work, work requiring attention and unchanging sensory stimulation is also monotonous work that places a strain on the body.

This is often caused by inappropriate design of the work site and poor design of tools, as well as a lack of variation in work. This places a strain on the musculoskeletal system and circulation in particular, but there may also be mental effects.

Make sure to vary with tasks where you move when there is long-term stationary or sedentary work. Avoid too many tasks where you have to keep tools and work aids in the same position for a long time. Breaks can also help to reduce strain.

Monotonous, repetitive work

When the same simple operations or movements are repeated within a cycle of 30 seconds, or when the same movements are repeated more than 50% of the working time and the same muscles are constantly strained, this is monotonous repetitive work (EGA). This work often takes place at a fast pace and requires concentration and attention, while at the same time involving strained working positions

7. LIFTING AND WORKING POSITIONS

with monotonous use of specific muscle groups. Therefore, your muscles - particularly in your neck, shoulders and arms - are almost constantly tense. This is very tiring and stressful for your body.

Working in a poor and perhaps fixed position with a lot of use of force increases the risk of industrial injury. This risk is worsened when the work site and tools are poorly adapted to suit the work.

An increased specialisation entails a risk of the work tasks becoming more and more uniform and unilaterally burdensome. For example, in painting work, iron binding, groove milling, screwing in of façades, roof or plasterboard where the same tool is used every day. Monotonous, repetitive work can also occur during excavation, shovelling work during bricklaying.

Plan and vary your work to prevent muscle problems. It should be possible to set your own work pace and be able to switch between different types of task.

Ergonomic design and adaptation of the work site and tools to suit individuals can reduce the strain caused by monotonous, repetitive work if the work pace is not increased at the same time. Short, frequent breaks with options for other activities can also help to prevent injury.

Avoid monotonous, repetitive work by making fundamental changes to the planning and organisation of your work.

TECHNICAL EQUIPMENT

Use appropriate technical equipment to relieve strain on the body where possible, especially if there is a risk of harmful effects.



Read more on technical equipment on www.bygergo.dk. Here are some examples of suitable technical equipment for different purposes and different types of work.

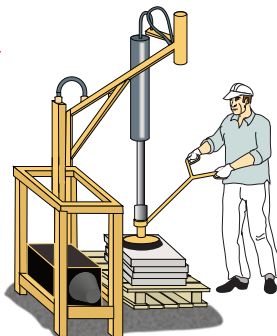

Hand-operated machines

When using hand-operated machines, the strain on the user must not be too great. This can be rectified by suspending the machine. In general, the weight and centre of gravity must be adapted according to the usage method and the time over which the machine is being used.



Proper positioning and handle design helps reduce strain.

The grip surface must be large enough to achieve even distribution of pressure. Your hands work best when bent back slightly. It is an advantage if handles on handheld machines damp vibration and are heat-insulated.



Driver's seat

A good seat provides full support in the lumbar region and back without locking theseated position. The following are also recommended for the driver's seat in cranes, fork lift truck and other contract machinery:

- The seat should support approximately 2/3 of the thigh length and have a rounded front edge. It must be padded and covered with a comfortable material which permits ventilation.
- It must be easy to set the height and tilt of the seat without tools. It should also be possible to move the seat backwards and forwards.
- It must be possible to adjust the suspension, shock and vibration damping of the seat according to the weight of the driver.

7. LIFTING AND WORKING POSITIONS

- The backrest must provide the lumbar and back with the necessary support, must not prevent arm movement and must provide the necessary seating support. Adjust the backrest so that the hip angle is 95-120 ° in a slight backward tilt.
- It should be possible to adjust the angle of the seat and the seatback independently.
- It should be possible to adapt the tilt to the work task, e.g. cranes may require both forward and backward tilt of the seat and backrest depending on whether work is taking place on the ground or high up.

HEAT AND COLD

Cold, rain, wind and draughts cool your body and increase the stress on the circulation and metabolism. The muscles and ligaments stiffen, and the risk of local overload of the musculoskeletal system is greater. When the hands are chilled, the sense of touch and ability to work are impaired. This increases the risk of accidents. People with a tendency to white fingers are at an increased risk if they are cold.

The temperature at which the work is carried out must be adapted to the body, taking into account the working methods used and the physical strain to which the employees are exposed.

Example: If the temperature is 10°C and the wind speed is 14 m/s, the temperature will feel like 5°C. The values in the table cover measurements at 1.5 m height.

Wind speed m/s	Temp in °C							
	10	5	0	-5	-10	-15	-20	
0	10	5	0	-5	-10	-15	-20	
2	9	3	-2	-8	-14	-20	-26	
4	8	2	-4	-10	-17	-23	-29	
6	7	1	-5	-12	-18	-25	-31	
8	7	0	-6	-13	-19	-26	-32	
10	6	0	-7	-14	-20	-27	-34	
12	6	-1	-8	-14	-21	-28	-35	
14	5	-1	-8	-15	-22	-29	-35	
16	5	-2	-9	-16	-22	-29	-36	
18	5	-2	-9	-16	-23	-30	-37	
20	5	-2	-9	-16	-23	-31	-38	
22	4	-3	-10	-17	-24	-31	-38	
24	4	-3	-10	-17	-24	-32	-39	
26	4	-3	-10	-18	-25	-32	-39	
28	4	-3	-11	-18	-25	-32	-40	
30	4	-4	-11	-18	-26	-33	-40	
32	4	-4	-11	-19	-26	-33	-41	

Cold index: DMI

In winter, for example, the temperature can be adjusted by heating workplaces in buildings. Normally, a temperature of about 10° will be appropriate for active physical work. For stationary precision work, a temperature of around 15° will be appropriate.



When working in shell houses, on scaffolding and open structures during the winter months (1 October - 31 March), the extent to which covers should be provided to protect against cold and draughts should be decided. This is a requirement if employees are exposed to adverse weather conditions for longer periods. When working in shell buildings, the limit is approximately three days and on scaffolding, etc., approximately six days.

At construction sites where several companies are working at the same time, the developer must decide who should be responsible for the covering and heating, and the extent of this. If more than 10 people are employed at the same time, this must also be stated in the Health and Safety Plan.

In the case of outdoor work operations taking place over a longer time, a screen must be set up to protect against the elements. Work huts, tents, canopies, etc. can be established. If drawing work, office work or other work is carried out on the construction site for long periods of time, this must take place in rooms where the layout complies with the rules on fixed workplaces. The room temperature must be at least 18°C. If the temperature cannot be adjusted, e.g. because work takes place outdoors or in the hall without the possibility of local heating, the employer must ensure that employees use suitable work clothing.

Limited working hours and protective workwear may protect against the cold. Workwear must fit well, offer appropriate insulation, allow moisture to pass through and have a windproof outer layer. The clothing must be able to allow excess heat to escape if the work is physically demanding. Protective clothing is a personal protective equipment to the same extent as protective footwear and the employer is responsible for providing and maintaining this. When working in alternately hot and cold conditions, it should be possible to alter and adjust your workwear accordingly.

7. LIFTING AND WORKING POSITIONS

Use a suitable surface if work is carried out lying down, sitting or kneeling with direct contact with cold or damp surfaces.

Strong heat and direct heat radiation from the sun may be stressful in combination with high ambient humidity. In addition to being exposed to fluid loss, the circulation is strained and body temperature rises, some people also react by becoming irritable and short-tempered. However, heatstroke is rare in Denmark.

A combination of physically heavy work, strong sunlight and hot machinery (e.g. when laying asphalt) can create a fairly high level of heat. It is therefore necessary to interrupt hot work frequently with breaks in colder surroundings. If you need to work in damp or hot surroundings, do not wear more clothing than is necessary for your safety. When doing heavy work, it should be possible to take sufficient breaks and working hours must be restricted where necessary. Drink plenty of water.

Working in protective clothing can cause a particularly large amount of heat stress as excess body heat and sweat are unable to escape. During hard physical work, fluid loss and rising body temperature can quickly become dangerous. Ensure there is plenty of fluid in warm and cold surroundings and limit any working hours or take breaks in the work. Use a sunscreen with a high protection factor and establish a shadow when working in strong sunlight.

EXCAVATION WORK

An experienced person should manage and monitor the excavation work, including the nature of the soil, and make decisions on slopes and the use of shoring devices.



Before starting excavation, it is necessary to check the following with the local authorities or utility companies:

- Soil contamination from previous production or landfills
- Any previous excavations in connection with utilities etc.
- Are there any installations in the ground that you should pay special attention to. This may, for example, be gas, electricity or communication cables. Wire information can be obtained from the cable register at www.ler.dk
- Excavation permit from the municipal authorities.

It may be necessary to inspect the soil before commencing excavation work to ascertain whether there is contamination present and to what extent.

General rules for safety when excavating with slopes

Depth of excavation	Excavations with slopes
Down to 1.7 metres	No special requirements unless, for example, the ground is unstable or kneeling is required.
1.7 -5 metres	The slope system must be 1: 2 (1 and 2 down)
5 metres or more	The slope must be 1: 1 (1 and 1 down)

8. WORK PROCESSES

General rules for safety when excavating at trenches

Depth of excavation	Backhoe diggers	Other options
Down to 1.7 metres	No special requirements unless, for example, the ground is unstable or kneeling is required.	Use of a shoring box, e.g. when the ground is unstable or when carrying out kneeling work.
Down to 2.25 metres	Clamps and plywood planks	The slope system must be 1: 2 (1 and 2 down)
More than 2.25 meters	In addition to clamps and strong plywood sheets, stretching boards must be used	Establishment of sheet piling wall, at large excavation depths, limited space or when excavation is close to a building.

Written assessment - work plan

During excavation work, the employer must assess whether particularly hazardous work is involved, e.g. work that involves a particularly serious risk of being buried, etc.

If this is the case, the employer must prepare a written assessment to counter risks. If necessary, this assessment must include specific arrangements so as to avoid any hazards.

Emergency preparedness

When planning excavation work, specific conditions may require preparation of an emergency preparedness plan. The necessary equipment must be on hand. This may include pumps, ladders, additional shoring materials, respiratory protection and special workwear if there is any risk of encountering contamination.

Safety during excavation work

Make sure that the soil is exposed, and use lamps at dark times of year. Rain, snow, frost, thawing and darkness can have a major impact on the safety of excavation work.

There may be sand veins, water-bearing strata (flow) and previous excavations with loose backfill. There is also a risk of collapse with all

excavation faces. Pay particular attention to e.g. sand, flow, marsh, water veins or a high water table.

Also be aware of buildings, structures, wires or trees close to where to dig.

If the soil is loose or if there are special stresses, e.g. vibrations from heavy traffic close to the excavation, this should be ensured further. The excavated soil must be placed at least 1 m from the edge of the excavation.

Excavation work near roadworks

A signposting plan must be drawn up if excavation work is carried out on or on roads with traffic. The local road authorities have to approve the plan, which must be compliant with the rules for boundary demarcation. Rules for marking can be found in BFA Building and Construction's handbook for marking for roadworks.

The distance between the work site and the road must be at least 1 m. This distance is important as vibration from the passing traffic may cause the excavation to collapse.

Excavation without shoring

It is important to ensure that the sides will not slip in the case of excavation without shoring. This should be done

- when establishing the site
- by keeping the sides even and free of large stones
- by placing the excavated soil at least 1 m from the edge of the excavation so that it does not lie on the edges or the excavated soil can slip down.

To prevent dangerous collapse, a so-called slope system can be made in which the sides are shaped as steps with a slope of 1: 2 (1 in and 2 up). In the case of excavation depths in excess of 5 m, the slope must have an incline of 1:1.

8. WORK PROCESSES

In exceptional circumstances, it may be justifiable to work in excavations without slopes at a depth of 1.7 m, if the earth has been deemed to be stable. However, it is normally necessary to safeguard against collapse when working on small excavations where personnel are to work in a kneeling position, for example.

Excavation with shoring

The excavation must be shored when it is not possible to create a slope system. This can be done in several ways:

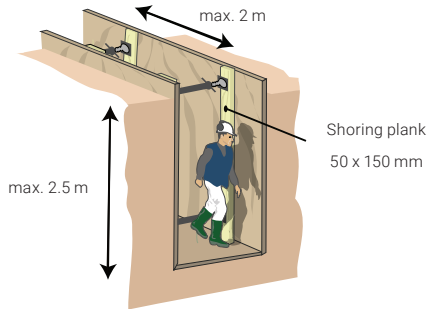

Use clamps when digging to a depth of 2.25. Behind the clamps there must be suitable plywood sheets on the upright edge protruding 0.15 m above the edge.



All excavations must have proper access and escape routes.

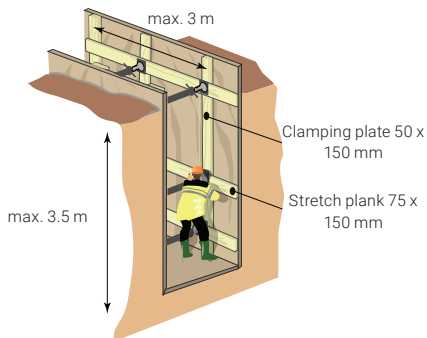

Use tensile panels if you wish to dig deeper than 2.25 m.

Use a shoring box. This must protrude at least 0.15 m up over the edge when it stands at the bottom of the excavation. The shoring box must reach all the way down to the bottom of the trench.

When using a shoring box, you must not leave the area secured by the box. It must also be possible to get out of the shoring box using a ladder.

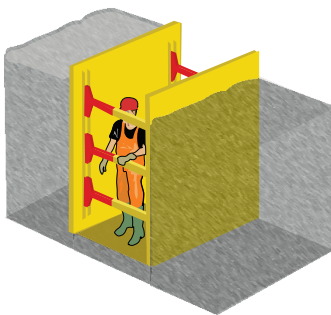

The same applies when establishing bracing with clamps or tensile panels. Prepare as much as possible at ground level when shoring work begins. The shoring is prepared on an ongoing basis from ground level and from the shored part of the excavation.

8. WORK PROCESSES

The risk of falling into trenches deeper than approx. 2 m must be prevented with effective collective measures, e.g. railings or barriers. This also applies to gutters under approx. 2 m depth if there is a particular risk of falling or injury.

In the case of large excavation depths, it may be necessary to establish a sheet pile wall.

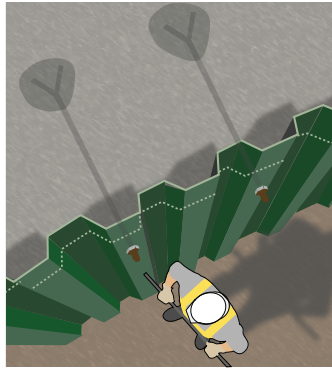

Excavation work close to existing pipework or cabling

Before commencing work, employees must be instructed in the correct distances and what precautions must be taken if a wire is hit, e.g. with the crane or excavator. These may include instructions on how to avoid fire, explosion, poisoning and suffocation.

Make sure that:

- You have information on all pipes and cables within 10 m of the excavation sites
- Installations in the ground are clearly marked
- Overhead cables, roads and cycle paths are clearly marked on drawings and similar.

Applicable safe distances when working close to overhead cables. The minimum distances shown must be respected.

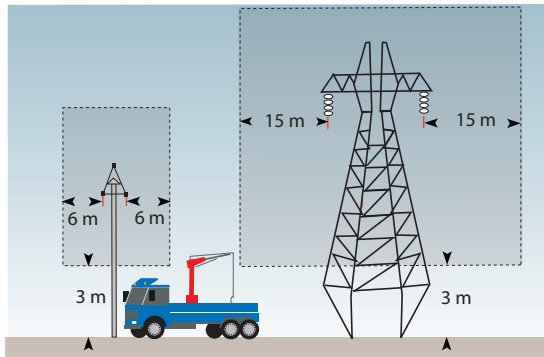

High voltage air line 10-40 kV

High voltage air line 40-400 kV

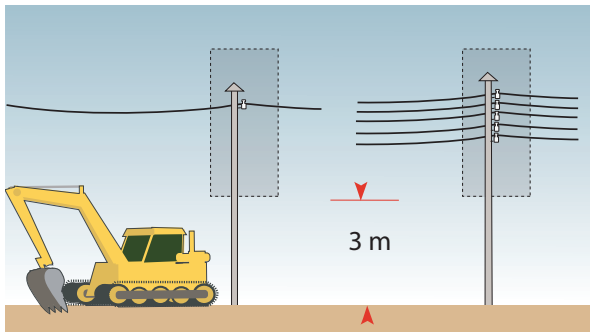

The safe distance in the case of low voltage overhead cables is a 1.5 m radius from the cable suspension point plus 3 m from ground level and up to this point.

Breaking of overhead cables or ground cables

If an excavator strikes an overhead cable or earth cable, the driver must proceed as follows:

- Stay in the machine until the power has been switched off.
- Keep everyone away from the machine.
- Notify the local power supply company, and call the emergency services (112) if necessary.

Access and escape routes



All excavations must have proper access and escape routes.

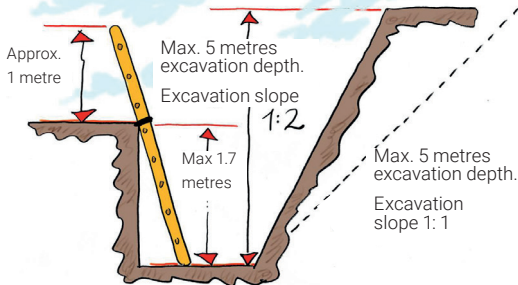

For small excavations, there must be a ladder near to the work site.

Open excavations

The risk of landslide is particularly great when work is taking place in an open excavation as the sides often have to remain where they are for a length of time and are so affected by the wind and weather.

Therefore, the faces must either be shored or have a slope when work is in progress between a foundation and a face.

The working area must be at least one metre wide measured at knee height (from the end of the threaded rod for formwork). The bottom of the open excavation must be flat and even so that people can work properly there. If necessary, put down a layer of road construction gravel.

Steps must ensure access to and from the open excavation. These must have handrails on both sides, with both hand and knee rails. If tools are to be transported using the steps, the latter must be at least 0.8 m wide.

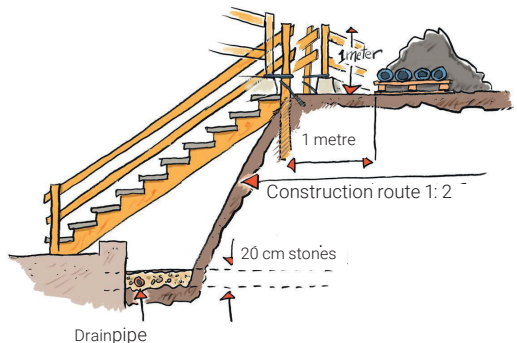

The stairway must slope according to the formula by two slopes and one reason = 0.60 to 0.63 m, and the individual steps must not exceed 0.2 m.

In construction pits, which have been spun, a stair tower will be erected as an access route or possibly a building lift.

There must always be a ladder close to work areas which can be used as an escape route between the foundation and the face.

It must not be possible for people to fall into the open excavation. Set up clear and durable markings at least 2 m from the edge or set up guard rails. The guard rails must only be open by the steps.

GAS PIPES

Work with gas pipelines requires special training and instruction as well as knowledge of the applicable rules. This applies in particular to instructions on the risk of accidents and illnesses - both verbally and in writing. The same is true for instructions on how to prevent fire, explosion, poisoning and suffocation.

8. WORK PROCESSES

Work must be monitored by a person who can come to the rescue in hazardous situations.

Everyone must be familiar with "First aid in the event of accidents involving gas". This is available as an annex to the Working Environment Authority's executive order on working on pipes filled with gas.

Always use meters which raise the alarm if the gas concentration becomes too high.

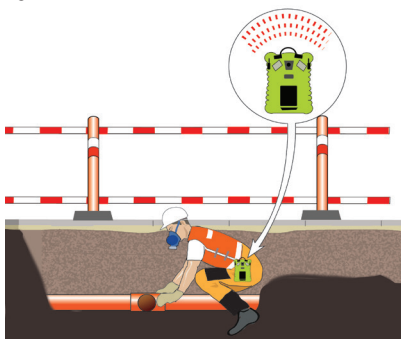

Use respiratory protection with an air supply when gases may occur in concentrations hazardous to health or displace ordinary air.

Working with respiratory protection requires planning. Physically demanding work may only continue for short periods and must be followed by breaks or other work.

CONSTRUCTION WORK NEAR TO WATER

There are special safety requirements for work near to water, e.g. harbours, quays, bridges, watercourses, lakes and dykes.

Scheduling the task must prevent dangerous workflows. If possible, there must always be more than one person working on the job so no one ever works alone.

The Danish Maritime Authority is the authority for the working environment at sea.

Their guidelines for contract works at sea can be found at www.sofartstyelsen.dk.

As a general rule, when work is carried out on water (vessel and platform), but is moored to the shore, the rules of the Danish Working Environment Authority apply.

In connection with construction projects near to water or at sea, or prior to such projects, you must:

- Describe how the project may affect navigational safety (risk of collision, etc.) and assess how any risk may be reduced.
- Hold a consultation with the users of the waters and the authorities, i.e. acquire statements from parties affected, e.g. the harbors authorities, pilots, the Danish Road Directorate, the Danish Coastal Authority, etc.
- Obtain permission from the Danish Maritime Safety Administration concerning marking by any buoys.
- Including the ability to communicate on the maritime VHF channels.
 - If the boat is less than 12 m long, it must be equipped with a radar reflector.
 - If work is being carried out in busy waters on a vessel that is more than 12 m long, it must be possible to emit an AIS-A signal (Automatic Identification System Signal).
- Inform the Seafarers' Alerts (Efs) no later than 4 weeks before you start, of the ships' names and call signals, which VHF channels are being listened to and other relevant information concerning the activity, so that seafarers can be made aware of the activity.
- If the project requires a temporary area with restrictions for the voyage, you should apply to the Danish Maritime Authority no later than four weeks before you begin.

8. WORK PROCESSES

- Take note of any special precautions if there are sea cables or pipelines are in the area.
- Be aware that there are different requirements for security testing depending on the type of vessel used.

There are special planning requirements if there is any risk of drowning. Before work starts, the following must be done:

- The contractor must prepare an assessment of the work with measures (work plan) so that the work can be carried out safely.
- The work is considered particularly dangerous when there is a risk of drowning. A health and safety plan must therefore always be drawn up, and contingency, evacuation and drill plans must be described in the plan.

The necessary safety equipment must be available at the work site and it may be necessary to wear a life jacket when working. Where possible, collective safety measures must be established, e.g. railings, etc.

Planning the work should prevent dangerous working practices. If possible, there must always be more than one person working on the job so no one ever works alone.

Working at sea

Personnel working at sea are dependent on the equipment they have with them and cannot expect to receive assistance from land. The wind and weather conditions must always be taken into account in the daily planning of work so that hazardous situations can be avoided. It may be necessary to stop work completely or temporarily.

An unsinkable dinghy is mandatory on a floating pile frame or pontoon, where there must also be maritime VHF channels which can be used in the event of an accident. Flash signals, etc. may be added if necessary.

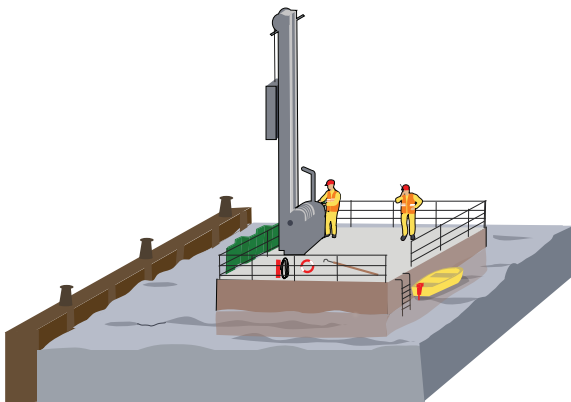

Signal rockets should be mandatory equipment for particularly exposed tasks.

There must always be lifebelts with lines, rescue hooks and fire extinguishers on all boats, pontoons and pile frames. There must also be a ladder so that any person who has fallen overboard can climb back on board.

All personnel on board must have received instruction in the use of the rescue equipment.

Life belts and first aid

All personnel on board must wear life jackets.

Assess whether it is necessary to wear a survival suit to avoid subcooling of the body.

There must be a first-aid kit on board, including a sling, which can be used when there is a risk of major blood loss from wounds on arms and legs.

At least one person on the working party must be able to administer first aid, i.e. stop bleeding and give artificial respiration.

ROADWORKS

 When working on roads or other areas where there is a risk of collision, measures must be taken to effectively safeguard employees, e.g. with screens and markings.

All work on and on roads, bicycle paths and pavements is covered by road regulations and must be planned in accordance with these rules.

Roadworks signage plan

 If work takes place on or on roads, cycle paths and pavements, the contractor must draw up a signage plan, which must be approved by the local highways authority. If the signage plan involves changes in the speed limit, road closures, diversions or, prioritisation, the signage plan must also be approved by the police. The signage plan must be available at the work site. The signage must be designed in accordance with the Danish Road Directorate's regulations.

The signage plan must be drawn up at the same time as the road project is being planned. This will make it easier to adapt working methods and processes to signage the plan to make it as effective as possible.

Equipment for roadworks signage must comply with the rules laid down in the Executive Order on Roadworks Signage.

Please note that certain road authorities and developers require that those carrying out roadworks have completed the course "The road as a workplace".

Protection levels

In connection with the signage plan, the protection levels chosen must be stated in connection with the planned roadworks. There must be a copy of this plan at the work site.

A distinction is made between 8 levels of protection, which indicate different types of measures.

The 8 levels of protection

Levels	Safety arrangements
1	E 53.4 Area with recommended speed 20 km/h (workers on the road) and speed reduction measures.
2	Edge marking or background marking
3	Work-free area ≥ 1.0 m incl. width of edge marking
4	Protection module, e.g. vehicle or machine with actual total weight ≥ 7 t at speeds above 50 km/h. Protection module with actual total weight ≥ 2 t can be used where the speed is 50 km/h or lower at specified separation distances.
5	Mechanical roadworks solely in vehicles or machines with an actual total weight of at least 1.5 tonnes and with drivers/assistants exclusively in designated areas that effectively protect against personal injury. Or remote operated machine.
6	Traffic barriers or collision damper. With lengthways barriers, safety fences must be used, while crash cushions can be used with transverse barriers, e.g. tyre columns with chain nets.
7	Secondary traffic barrier
8	Barriers over the entire road or road side on roads with central reservations or crossing motorways.

These depend on:

- What type of roadwork is it?
- Where is the work to be carried out?
- Traffic density and associated speed limit
- Duration of intended roadworks.

8. WORK PROCESSES

It is assumed that the speed limit along the roadworks does not exceed the specified speed for the roadworks. If this speed is not respected, additional measures must be taken.

In addition to the above-mentioned security measures, it is assumed that:

- road work personnel wear reflective/warning clothing of the correct class;
- vehicles in the traffic area have their end-outline marker lights on (yellow indicator lights);

The eight levels of protection are further explained and illustrated in "Pocket book for marking roadworks, etc.", which can be downloaded from www.bfa-ba.dk

Signs

Signs and other equipment for marking roadworks must always be in the correct condition, properly maintained and used correctly. It is also important to select the right equipment which e.g. is of the correct strength and will not topple over so that it is able to perform its function even if it is subject to severe physical loads.

Examples of roadworks marking equipment:

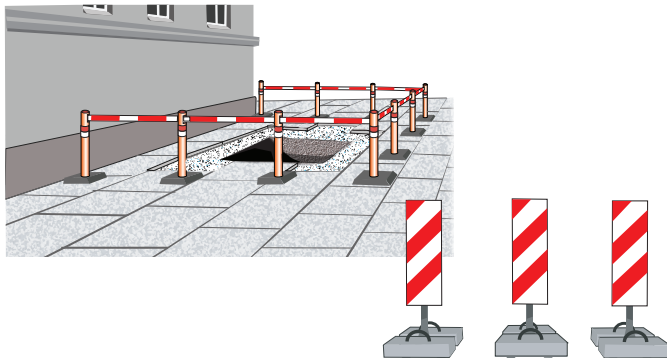

Traffic barriers

Traffic barriers must protect both road users from driving into the excavation, and they must safeguard those who are working against collision.

When positioning the traffic barrier, this must be done in accordance with the manufacturer's instructions, including the deflection width at the set speed. The traffic barrier must be placed with an absolute minimum distance corresponding to the maximum deflection width.

Do not stay in the work area and do not store tools and excavated soil. The work area must be kept clear of traffic.

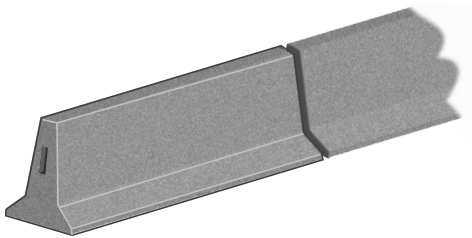

The traffic barriers used must be tested and approved. Traffic barriers are strong barriers that can withstand collisions (steel crash barriers or concrete elements that meet the test requirements of DS/EN 1317-2).

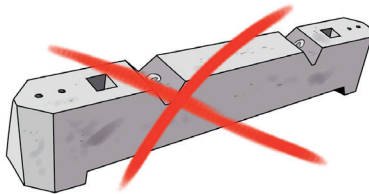

Concrete blocks are not traffic barriers

Red/white plastic tape is not an approved marking material and must not be used.

Illuminated signs

Light markers of various kinds are another highly effective marking material and are often used for short work tasks (placed on panel trolleys, longitudinal light lines, transverse light, etc.). If a strong warning light is required, ensure that the required amount of current is available.

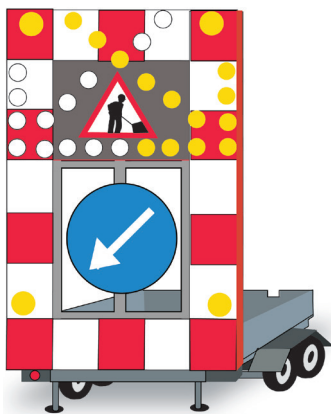
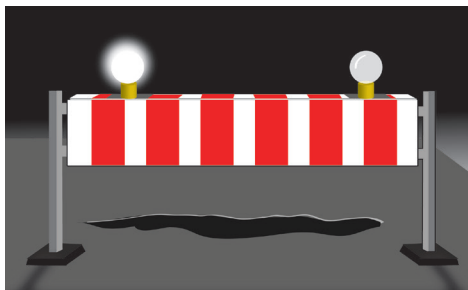

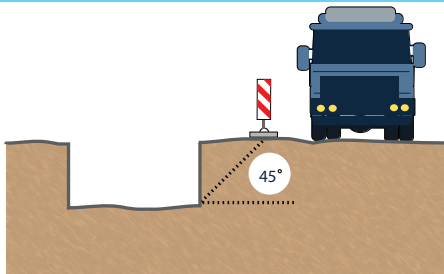

With roadworks where excavation work is carried out and excavation work on installations, the distance from the edge of the excavation to the roadway must be at least the same as the depth of the excavation. This distance is important as vibration from the passing traffic may cause the excavation to collapse.

Stationary and mobile roadworks

There are two types of roadworks:

1. Moving roadworks means both rolling work with machines and short-term work where the signage is not left overnight.
2. Stationary roadworks are normally works where the signage must remain overnight.

A work area is the road area for which the contractor is granted the right and responsibility and which has clearly defined boundaries to the traffic area and neighbouring areas. The work area includes areas for road signage and cordoning off of the traffic area and neighbouring areas.

When working at height, the work area also includes the necessary free area around the lifting equipment. If the work area contains excavations without shoring or structures steeper than 1: 1, an area along the excavation towards traffic with a width equal to the excavation depth must be included in the work area.

8. WORK PROCESSES

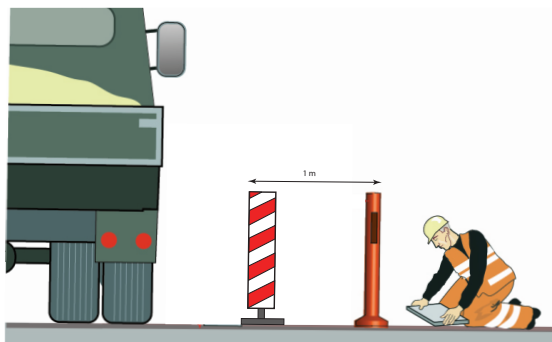

A non-working area is a sub-area of the working area towards the traffic area where there are no roadworks, where personnel may walk or where materials are stored.

The boundary between the work site and the work area is marked with visible and durable signs, e.g. by using stripes or cordoning off, so that road workers do not inadvertently enter the work area. The work area must not be used by pedestrians and cyclists.

The marking must consist of a transverse marking facing the traffic and a longitudinal marking between the traffic and the work site. There must be a visible marker so that the clear area can be kept free.



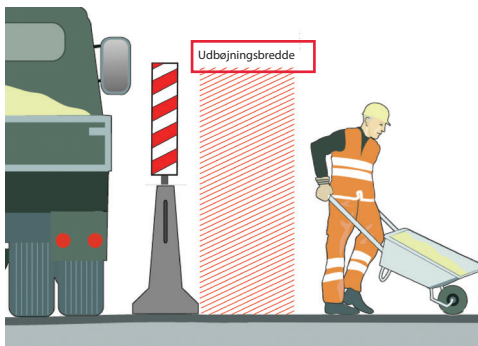

Protection level 3 can be used where extra safety clearance is required. Protection level 3 is also called the "perimeter" and the distance between the traffic area and the work site is measured including the length barrier.

Traffic barriers can be used for bridges or stationary roadworks, e.g. excavation work, pipe work, bridge work, scaffolding work or high-speed traffic management. Manual roadworks must not be carried out within the deflection width of the traffic protection equipment. In the case of manual roadworks in the vicinity of the traffic barrier, the deflection width of the barrier must be marked with clear and durable signage along the work site.

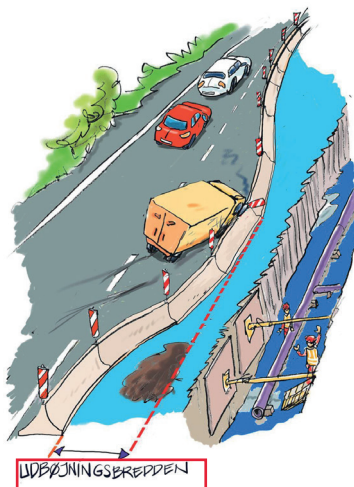

Reflective workwear

When working in roads and road areas, reflective work clothes must be worn so that employees and visitors are visible to road users.



Reflective clothing is divided into three classes:

- Class 3 - reflective clothing should be worn if the surrounding traffic exceeds approximately 60 km/h (25 mph).
- Class 2 - reflective clothing or higher class should be worn if the surrounding traffic is travelling between approximately 30 and approximately 60 km/h (19 and 140 mph).
- Class 1 - reflective clothing or higher class is selected if the surrounding traffic is travelling at approximately 30 km/h (18 mph) or less.

It is assumed that the speed limit along the roadworks does not exceed the specified speed for the roadworks. If this speed is not respected, additional measures must be taken.

Please note, however, that traffic may still have a higher speed than the sign. Always use class 3 clothing in case of doubt, e.g. in working positions that reduce the visibility of reflection or if the need changes.

Class 2 or 3 should only be used for roadworks. The part of the fabric which reflects the light must be yellow, orange or red.

If reflective clothing is used at the same time in connection with welding work, the clothing must also be flame-retardant.

Cleaning

Poor or incorrect cleaning of reflective workwear makes it less visible. This can generally only be seen when a light is shone on the clothing in the dark. Impaired effectiveness can lead to serious accidents, and so it is important to follow the guidance of the manufacturer in respect of cleaning and washing.

DEMOLITION

Demolition of buildings requires planning and preparation. Walk through the building or structure before starting work.

Any person who designs a construction or civil engineering project involving demolition must design the project in such a way that the demolition can be carried out in a completely responsible manner in terms of health and safety. The project planner must advise the client of any necessary investigations, e.g. checking for asbestos and lead, etc. in the building.

In many instances, demolition of building or larger partial demolition work should be regarded as being a hazardous activity. This means that the developer, at construction sites where there are more than one employer at the same time, must prepare a Health and Safety Plan for this work.

The employer must assess the work, specifying arrangements so that the work can be done safely and appropriately from the point of view of health and safety. This assessment must be submitted in writing.

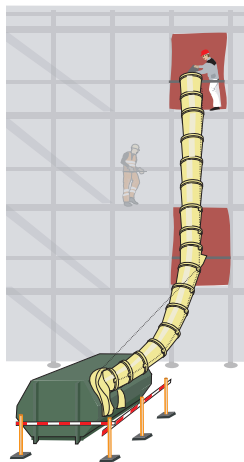

8. WORK PROCESSES

The building or structure must be assessed with regard to the following:

- Are there materials that are hazardous to health, structural elements or residues, such as:
 - asbestos, PCB, chlorinated paraffins, paint with heavy metals (lead, zinc and mercury)?
 - anesthetic syringes/needles, batteries or faeces from humans and animals?
- For example, has the building been used to store mercury-blown grain, feedstuffs or was it heavily damaged by moisture (biologically active dust)?
- Could the ground be contaminated?
- Could selective demolition weaken the stability of the structure?
- Does demolition require special measures for the surrounding areas, e.g. with regard to vibration, noise or dust?
- Are there any electricity, gas, water or other installations requiring special consideration?
- Is it possible to carry out the work in a different way which is less stressful for the working environment, e.g. blasting or cutting in place of hammering or drilling?
- Does the insulation granulate have to be removed before demolition to avoid dust?
- Is there any pre-stressed concrete with reinforcement wires?

If the assessment shows asbestos, PCB, old mineral wool, paint with heavy metals (lead, zinc and mercury) or faeces, for example, this must be removed before the actual demolition work commences.

Demolition work must be managed and monitored by an experienced person who can assess whether the building elements remaining are stable. The people carrying out the actual demolition work must also include people with experience.

Minors under 18 may only work with demolition if this takes place in connection with industrial skills training, e.g. as apprentices, and they have received proper instruction.

Checklist prior to demolition

Before demolition work commences, the contractor must ensure:

- that electrical cables, gas pipes, etc. have been disconnected (by an authorised installer)
- that the work area is cordoned off and that temporary bracing and securing measures are regularly installed
- that there is the necessary bracing material
- that doors and windows are covered so that materials do not fall out
- that a security guard can be employed, if necessary;
- that transport and traffic routes are secured with covers, if this is required
- that the work is carried out in the order specified in the tender documents and timetable
- that the necessary signs have been put up
- that unstable structures are secured
- that the necessary scaffolding and other technical equipment is available
- that personnel have the necessary personal protective equipment and that they use it, e.g. helmet, respiratory protection and safety footwear
- that waste is placed and disposed of in accordance with the tender documents
- that machines and facilities are properly cleaned and prepared in terms of health and safety before and after use, e.g. whether abandoned technical equipment, machines, pressure and material containers, lifts, equipment with radiation sources, etc. have been taken into consideration.

Dust

Reduce the amount of dust in the air by means of extraction, cleaning with a suitable vacuum cleaner and spraying with water. If necessary, wear dust masks, goggles and dust-repellent workwear.



A half mask fitted with a class P2 dust filter can be used as a dust mask or even better, a full face mask. It is a good idea to use a coarse dust filter to protect the fine dust filter.

8. WORK PROCESSES

Traditional disposable masks will normally not be suitable for demolition or similar very dusty work.

As demolition work in many cases generates a lot of dust, it must be demarcated from other work areas. Respiratory protection equipment will in many cases be necessary during the entire working hours within the defined area. Here, it will not be possible to use ordinary filtered respiratory protection as this may only be used for three hours over the course of a working day. Instead, a suitable turbo filter mask or respiratory protection with an air supply can be used. Read more about the use of respiratory protection equipment in Chapter 10.

RENOVATION



Before renovating a building, a condition assessment of the property must be carried out. This must identify the risks related to the working environment and describe a realistic timetable already in the tender phase.

The condition assessment should include the following:

- Stability of the structure if altered.
- The load-bearing ability of the building at points where work is being carried out.
- Locations of electricity, gas and water installations.
- Risk of contact with substances and materials which are harmful to health, such as:
 - asbestos, old mineral wool and PCB,
 - wet rot and dry rot,
 - animal and human waste.

Renovation jobs typically take place in existing buildings, where the work may be heavy, difficult and physically demanding. Therefore, it is important to establish good access and transport routes. This makes it easier to move building materials around and makes it possible to use technical aids to transport them.

Reduce dust by:

- using an extraction fan on drilling or cutting tools
- using exhaust ventilation with an outlet to the outside
- dampening areas with water to lay the dust
- avoid cutting into concrete. Blasting or cutting concrete reduces the amount of dust
- clean the work area continuously, e.g. by vacuuming with a class H vacuum cleaner. It is always a good idea to involve users and residents in the planning of renovation jobs. According to the Rent Act, they must at least be told that the work is to take place.

REMOVAL OF CONCRETE

Quartz dust can be generated when removing concrete, particularly when a chisel hammer or similar is used. Crushing, cutting or blasting the concrete will limit the amount of dust generated. The choice of method depends on the individual task.

Blasting may only take place when a trained blasting expert manages the work. Minors under 18 may under no circumstances take part in work where there is a risk of explosion.

PRECAST PANEL INSTALLATION

Element installation is regarded as particularly hazardous work, where the developer must draw up a Health and Safety Plan (HSP). In the case of particularly hazardous work, the employer must also make a written assessment with measures (work plan) so that the work can be carried out in a completely safe and healthy manner, and it must be included in the basis for the start-up meeting and the instruction of the employees.



8. WORK PROCESSES

Project planning

Many parties are involved in a project with precast panels. During the project phase, the client's coordinator must check that the temporary statistics for the building have been taken into account while it is being constructed. This includes creating a plan for temporary shoring and when it may be removed. It is important to coordinate the work prior to installation and at the same time to review every detail of the project. This must take place at a meeting where the Health and Safety Plan may be adjusted. The contractual basis is determined according to the models in BIPS/A113.

Start-up meeting

The installation gang must have instructions on installation at a startup meeting. Here, the project documentation, Health and Safety Plan, supplier information, special elements, control points, crane placements, etc. must be reviewed.

The location of roadways, storage areas and work areas for cranes must be described in the developer's Health and Safety Plan.

The installation guide must describe correct installation and propping.

Transport and unloading of concrete elements

There must be a level and horizontal surface with sufficient load-bearing capacity, where wall pallets/flats etc. can be placed.

Ensure that the rig is secured against falling, both when unloading from lorries and flats.

Precast panels must be unloaded according to the supplier's instructions.

If a pallet is defective on delivery to the site, e.g. if the panels do not engage in dowels, the supplier MUST specify an alternative way of unloading the panels. Otherwise the panels must be returned to the supplier.

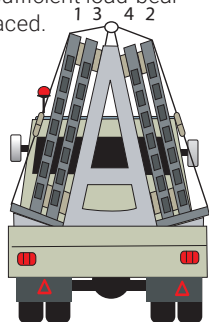

Temporary storage on site should be avoided as far as possible. If re-loading or temporary storage is necessary, this must always be done in accordance with the supplier's instructions. Storage will normally take place on dedicated racks/pallets or flats.

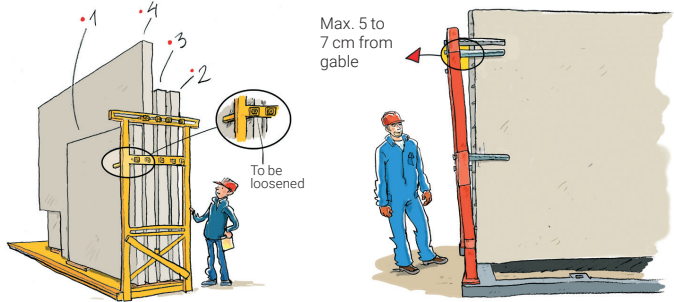

If other storage methods are chosen, this is liable. It must therefore be ensured that reloading and storage have at least the same level of safety as the method described in the supplier's instructions.

Crane selection

When using a crane, its lifting capacity must be great enough to allow the precast panels to be positioned correctly and safely. The weight of the element is indicated on the element label. Note that the tolerance on elements is $\pm 10\%$ of the weight of the element.

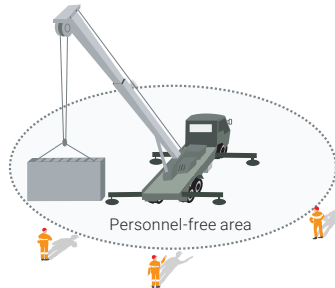

Dowels

There is a "standard" for dowel sizes:

- 40 mm, max 4.5 tons, 100–800 mm element width
- 60 mm, max 10.5 tons, 200–800 mm element width
- 90 mm, max 25.5 tons, 200–1200 mm element width

One dowel of grade 34CrNiMo6 is required. Webbing or a chain must be placed as close as possible to the panel to be lifted so that the dowel does not bend. Use spacer tubes.

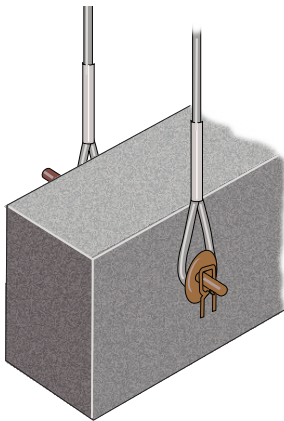

Installation

To plan safe, correct installation, you need to use all the information that may influence the temporary propping of the concrete panels. It is the responsibility of the installation manager to acquire this information. This information must include a calculation and decision on the overall temporary statics and hence for the temporary propping as well.

The supplier must provide the necessary instructions for installation of individual elements.

The sequence of the precast panels and the temporary propping is determined on the basis of this information.

While installing concrete panels, other work must not take place nearby at the same time. The employer's written assessment of the work must define where and when other work may be carried out, including grouting.

Shoring

Temporary shoring of the concrete elements must take place in accordance with the shoring plan, which is designed on the basis of the construction's temporary statics and the instructions of the individual concrete element suppliers.

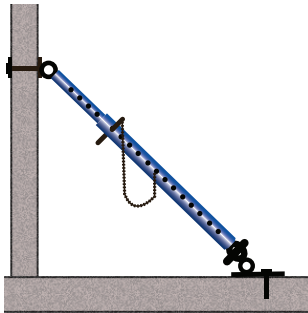

The general rule for shoring is that all elements/columns must be shored with at least two element supports, unless the consultant/supplier states otherwise. The requirement is that bracing must be sufficient, i.e. one must take into account the element's area, installation height above ground level, terrain class and current weather conditions, i.e. make an assessment in each individual case.

Columns must be fixed at the bottom in the manner prescribed by the supplier. Always check the supplier's instructions for use.

When securing in hollow core slabs or not fully cured concrete (including elements), it may be necessary to verify whether the required pull-out value can be achieved.

Concrete screws should only be used once – defective thread reduces the extraction value.

8. WORK PROCESSES

Tightening torques for bolts are dependent on the inserts used and must be implemented in compliance with the supplier's usage instructions.

When tightening, use a torque wrench.

If you are in any doubt about the tightening torque, ask the supplier. Read more about this at Betonelement-Foreningen's website www.bef.dk

The end surfaces of the panel supports must abut fully against the precast panel and the floor.

If the design of the project requires specially designed fittings, the project manager shall provide information on this.

Removal of shoring

Do not remove shoring until the building is stable. This will only be the case when foundations, etc. have set sufficiently. This must be specified in the project documentation.

Façade and wall elements

When installing outer walls, the guard rails must be in position prior to installation.

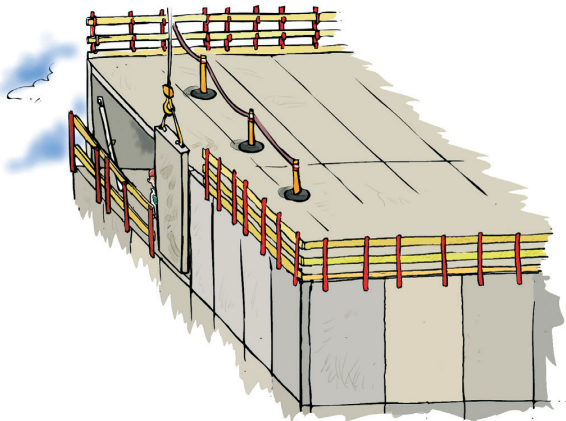

Remove the guard rails again either as installation progresses or at a later date. The structure has to be secured to prevent falling when the guard rails are removed, e.g. by using fall protection equipment.

Installation of floor/roof elements

When installing floors, the load-bearing structures must be grouted beforehand or the load-bearing capability must be assured in some other way.



There must be guard rails along the façade which can easily be continued to the front of the installation. Plan the erection of railings prior to erection. If necessary, mount the balustrade before lifting the elements, so that it is easier to mount the railings afterwards.

There must always be guard rails behind and along the outer side of the front of the installation.

8. WORK PROCESSES

Floor elements must be laid in parallel as this minimises the risk of falling and tilting.

During installation work, measures must be taken to prevent falling, with fall protection equipment as a minimum requirement.

Traffic and work may only take place in the part of the building where element erection takes place if there are two finished levels in between.

CRAWL SPACES, ATTICS AND ROOF SPACES



Work in enclosed spaces can be split into two groups:

1. Installation work in new buildings, including major conversions and renovations.
2. Repair and maintenance of installations in existing buildings.

Personnel can be exposed to ergonomic strain on the entire body both during installation work and repairs.

It is often necessary to creep or crawl in poor positions and in many cases over various obstacles, e.g. installations at different heights.

Consequently, the risk of occupational accidents is often greater, there is wear and tear where, among other things, knees are very vulnerable, and the work can be psychologically stressful.

When working in confined spaces, it may be necessary to supplement the work place assessment with a description of the conditions at the work site, including access conditions and escape routes.

It may also be necessary to create an emergency, evacuation and exercise plan. It must describe how the injured person can be evacuated and must be approved by the local rescue corps.

New construction

In the case of new construction, the problem is more or less resolved. Building Regulations state that the access height must be at least 1.9 m and a free width of at least 0.7 m in crawl spaces with installations requiring servicing, inspection or maintenance.

If the installations can be serviced via a removable floor, setting up a crawl space is fine.

Existing buildings

In existing buildings, it is often impossible to alter enclosed spaces. It is important to plan the work so that the amount of time spent in stressful working positions is as short as possible.

This can be done by:

- limiting daily working hours
- giving personnel the opportunity for extra breaks in addition to their regular breaks for eating and drinking
- not working alone (regular contact with the employee)
- ensuring that employees receive special work clothes, suitable respiratory protection if necessary, and other personal protective equipment (including knee pads, helmets and soft insulating pads to lie/sit on during work)
- ensuring that the orientation and work lighting is in order and connected to two different groups in the electrical panel
- small trolleys are used to transport tools and materials wherever possible
- that there is equipment available to evacuate any injured person as easily as possible
- making sure that the distance between the access points is around 15 m (it may be necessary to make more openings in the existing buildings or to the outside). Access openings must be at least 60 x 80 cm
- ensuring that there is a convenient route to the access point in places above or below the main level of the site

8. WORK PROCESSES

- thoroughly cleaning the work site before starting work.

ensuring that the distance between the work site and the exits should be even shorter than the maximum limit, if there is a risk of fire, steam, etc, if there are pipes or the like that impede the escape routes, or if visibility is limited.

Use the assessment schedule (see below) to set the maximum daily working time in a crawl space.

Crawl space height	Maximum working hours distributed over one day	Factors that may further limit the daily maximum working hours - or completely exclude a person from work
Between 60 and 90 cm	1 hour	<ul style="list-style-type: none">• Use of respiratory protection equipment• Use of other personal protective equipment that may, for example, limit the free standing height• Particularly stressful working or access positions• Psychologically harmful working conditions• Personal conditions, e.g. health and weight
Between 90 and 120 cm	2 hours	
Over 120 cm	4 hours	
The actual standing height of the person (s) performing the task in the crawl space	General length of working day	

Emergency lighting is mandatory while working in a crawl space. For example, this could be a battery lamp that can be used as an orientation light in case of power failure.

Dust, asbestos, etc.

 When working in basements or roof spaces, there is a greater risk of dust, insulation materials and construction material remains which can be harmful to health. In buildings dating to before 1990, there is a risk of contact with insulation materials which contain asbestos. Be aware that asbestos dust from e.g. roofing sheets and pipe insulation can lie in the basement, ceiling and sight rooms and pose a health risk, even if these materials are not interfered with in the actual work.

If asbestos is present, the work area must be cleaned before work may commence. This cleaning must be undertaken by people trained in the removal of asbestos.

In moisture-damaged buildings, attention must be paid to biologically active dust – mould, etc.

In other situations, it may be necessary to tidy up before work can begin, e.g. if there is too much dust, animal excrement or construction waste.

Do not crawl around in rubble and other construction waste as this may damage your hands and knees.

Work in lofts, roof spaces and crawl spaces requires a lot of attention and must always be planned. The necessary aids, protective and technical equipment must be available before work begins.

See more about asbestos at www.asbest-huset.dk



WORKING IN ENCLOSED SPACES AND WELLS

Always prevent accidents by suffocation, poisoning, etc.

Be particularly vigilant when working in:

- wells
- pump stations
- tunnels
- pipelines
- silos
- shafts and similar structures.

Minors under 18 must not work in enclosed spaces, wells, pipes, etc., if there is a risk of suffocation or explosion.

Much of this work will be particularly dangerous work. The employer must therefore always make a written assessment with measures so that the work can be carried out safely.

8. WORK PROCESSES

If personnel from more than one employer are employed at the workplace, the developer must prepare a Health and Safety Plan (HSP) for the work.

Well work in sewer and wastewater treatment plants

There must always be two persons on the surface above the stairway when working in wells, in sewers and wastewater treatment plants. They must be in constant contact with the personnel working in the well. An assistant is often also required whom the person on duty on the surface can summon quickly for help if necessary.

Before work begins:

- Well sides and ladders, etc. must be inspected to make sure they are safe
- Any damage must be repaired
- The well must be ventilated efficiently – blow in fresh air if necessary
- Before descending, check whether the air in the well is fresh and sufficiently oxygen-rich. Repeat these measurements while work is in progress
- Targets for oxygen content, hydrogen sulphide and explosive substances
- Should an emergency occur, it must be possible to rescue personnel working in wells easily. Always use a hoisting harness and line. The line must be connected to a tripod with winches or similar.
- Personnel must have received instruction and training on the use of rescue equipment, etc.

If it is unavoidable to enter a well which cannot be ventilated properly, the following applies:

- Use suitable respiratory protection (with an air supply).
- Tools, equipment, lighting and clothing must be prevented from generating sparks.
- The person on watch must be equipped with additional respiratory protection with an air supply.

If there is a risk of explosion, smoking and naked flames are prohibited near the well.

Other well work

In the case of other well work, a concrete risk assessment must be carried out and some of the same measures must be taken as when descending into sewers, such as thorough ventilation or other measures that protect against possible odours from soil contamination, lack of oxygen, etc.

There must be a rescue option for persons in these wells. This can be via a suitable hoist, hoisting line and harness so that in the event of accidents or unforeseen events, the person can be hoisted up from the well. This will require at least one watchman.

A hoisting line secured to a hoisting harness is often the only way of rescuing a person from a well. This could, for example, be if the person has been injured or is unconscious due to gas or insufficient oxygen in the well.

An unconscious person cannot be pulled out of the well by hand. A suitable hoist must therefore be fitted over the well.

A vehicle with a mechanical winch can also be used as a hoisting tool if it is possible to position the vehicle close enough to the well. A vehicle with a mechanical winch can also be used as hoisting gear if it is possible to place the vehicle sufficiently close to the gully.

The person on watch must be trained in how to use the rescue equipment correctly and be aware of how he can summon help quickly. The watchman must also be able to call for help, e.g. by telephone/radio.

Hoisting harness

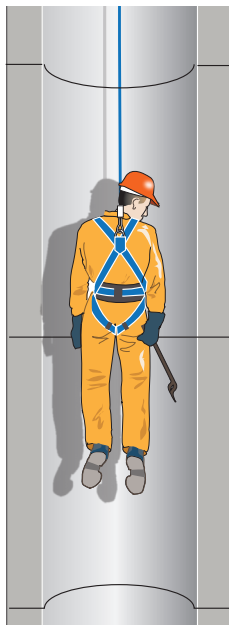

Drain work

Special rules apply to work on drainage facilities used. This requires a knowledge of and instruction on how to work in drains. People who spend most of the day working in drains must have been vaccinated in compliance with the requirements of the Working Environment Authority.

Measure continuously for oxygen content, hydrogen sulphide and explosive substances - and take precautions accordingly.

Always wear the most suitable workwear for the task in hand. If clothing is made wet, it must be possible to change into clean, dry workwear.

There are special requirements for separate showers, changing facilities, separate workwear/everyday clothes and requirements for shower after work ends.

Personal hygiene

First-aid equipment with - among other things - an eye wash bottle must be situated close to the work site.

Clothes must be changed before eating to avoid eating while wearing workwear.

Enclosed spaces, pipes, etc.

Work must not take place in pipelines less than 1.2 m in diameter. However, exemptions to this can be applied for from the Working Environment Authority. Such permission is granted only in special cases and a long list of special arrangements must be complied with. Among other things, there must be a detailed plan which shows arrangements for other ways of countering risks to health and safety at work.

The work must be short-term and working hours in the pipeline must be limited.

In the case of serious accidents, it is possible to deviate from the special arrangements if absolutely necessary. In such instances, the working environment organisation should have compiled guidelines and procedures and an evaluation within the working environment organisation should always take place afterwards.

In such special cases, it will normally be possible to use crossover harnesses with ankle ties to be able to pull the person out.

There must be an intermediate position if the person on watch is unable to maintain contact with the people in the pipeline or well. This person must remain between the work site and the person on watch and be able to communicate with both.

District heating plants

When working in district heating plants, it is necessary to prevent the risk of scalding while at the same time complying with the general rules for working in wells, pipelines and enclosed spaces.



Personnel must have access to cold drinking water when working in areas with temperatures above normal.

Working in enclosed spaces is demanding. Working hours should therefore be limited. Workers must take regular breaks and swap to different tasks.

Please note that older district heating systems may contain asbestos insulation.

HOT WORK

Hot work covers all work which involves a risk of igniting building elements and similar. Thus the term "hot work" covers all work involving naked flames. However, it also applies to work with tools which give off heat where there is a risk of fire starting, e.g. angle grinders, circular saws, tools for drying and soldering, etc. Therefore, the rules and practice mentioned can also be used in connection with such work.



Hot work is often the cause of fire because employees are unaware of how they can prevent fire. Therefore, it is important to prepare effective safety procedures and ensure that everyone understands the fire risks and has received good instruction.

8. WORK PROCESSES

Please note that there may be special challenges for escape and evacuation when working in high buildings where the fire service cannot carry out rescue from outside. It is therefore particularly important that the contingency plan takes this challenge into account and that fire and evacuation exercises are carried out. Insurance companies have requirements with regard to hot work. Typically, any company carrying out hot work will be covered by the developer's building insurance.

Complete an agreement form on hot work before work commences. The form is available from the Danish Institute of Fire and Security Technology at www.brandogsikring.dk

Good planning can prevent the risk of fire and explosions. How this is to take place must be specified in the tender documents or be described in the Health and Safety Plan.

In many instances, it will be necessary to have a person on watch for a period after the hot work has been completed.

The employer is obliged to notify employees of the risk of fire and to instruct them on how to prevent fire and fight any fire occurring.

Risk of fire

There are two categories of fire risk during hot work:

1. Failure or misuse of tools
2. Heat and sparks from work that ignite flammable material

In both situations, the risk of fire can be averted by simple means:

- Check that the tool has been correctly maintained and is only used as specified by the manufacturer.
- Remove all flammable material, e.g. known pyrophoric products/processes (linseed oil and similar rags). If it is not possible to remove the material, store it in a suitable container.

Examine buildings for anything particular which has to be taken into account before work commences.

- Are inflammable materials, liquids or gases being stored?

- Are there any spaces containing inflammable materials?
- Are there any concealed cable conduits or extraction ducts which open out beneath or just over the roof, from which inflammable vapour or dust could blow out?
- Are there any old papers, spiders webs, etc. which could easily catch fire and start a major fire?

Other areas which require attention:

- Waste and empty packaging must be thrown into suitable containers routinely.
- Always keep the escape routes clear.
- Store welding equipment properly once work is finished.
- Smoking is prohibited in any location where solvents and mixtures containing solvents are used and stored.
- Place foam extinguishers on every floor.
- Set up signs near to foam extinguishers, with arrows showing where they are.
- Inform employees about fire safety.
- Check if there are conditions or materials that require other extinguishing types than foam extinguishers.

Signs with information about the address of the site will be posted on all floors, possibly also that an employees will be posted at the entrance to the site to show emergency services the route to the accident site. Store any alarm centre numbers on the mobile phone. In some locations it may be wise to have GPS coordinates to give to the alarm receiving centre.

During cutting, grinding and welding, the heat is primarily propagated as sparks from the material being worked on.

Extinguishing equipment

Regularly check extinguishing equipment and make sure that fire extinguishers have no visible faults or defects, that the seals are intact and that the pressure gauge is displaying the correct pressure.

8. WORK PROCESSES



Extinguishers in poor condition give a false sense of security and cannot stop a fire before it develops.

Extinguishers must be approved and marked "DS". According to the law, only a DS-approved filling station may fill and pressure test the extinguisher at least every five years.

If an extinguisher is used outdoors, is subject to changeable weather or is often transported, it must undergo a service inspection by a DS-accredited servicing company at least every six months.

Working with naked flame

Use of naked flame, also known as hot work, includes work such as roofing and welding.

The employer is obliged to notify employees of the risk of fire and to instruct them on how to prevent fire and fight any fire occurring.

Avoid naked flames that may come into contact with inflammable materials or building elements. Also make sure there are no cracks or joints in building elements and covers which burning/glowing materials can penetrate.

Watch out in particular for fire in small cavities, e.g. during roofing and metalwork. Fire can make a lot of progress in small cavities and ignite inflammable materials far from the work site.



Divide up the planning of the work as follows:

- Precautions before starting work
- Organisation of the workplace and escape routes
- Carrying out the work
- Precautions during work
- Fire precautions
- Precautions when work is completed, including fire watch.

WELDING AND CUTTING

Welding and cutting smoke contains gases and a number of heavy metals which together can cause chronic bronchitis and cancer of the respiratory tract. Therefore, this smoke must always be removed effectively. Make sure you protect your skin from ultraviolet light and sparks. The light from welding can also cause permanent eye damage.

Materials with surface coatings

Grease, paint and other surface coatings must be removed before welding commences. Clean mechanically as far as possible and only use organic solvents if you cannot get the surface clean in other ways. Always wear appropriate respiratory protection and ensure solvent residues are removed before welding.

Welding smoke

Remove welding smoke and grinding dust using suitable ventilation and extraction facilities. Use a portable system if it is not possible to set up a central extractor. If this is not possible either, use suitable respiratory protection.

Local extraction ventilation must always be used to remove smoke when welding. If smoke is not effectively removed, fresh air supplied respiratory protection equipment must also be used at all times wherever welding is carried out, including outdoors.

8. WORK PROCESSES

If it is not possible to establish effective process ventilation with extraction to the outdoors, a decision must be made on how to avoid spreading to others on the construction site, and signs must be hung up stating that work and traffic in the area may only take place with suitable respiratory protection equipment.

Noise

Metalworking such as cutting and grinding creates noise that can be damaging to hearing, and should be counteracted by encapsulation, noise attenuation, etc. It may be necessary to wear suitable ear protection. Other people must not be subjected to noise which is unnecessary or could be harmful to health. Areas in which ear defenders are to be worn must be demarcated, and signs must be put up stating requirements for the use of ear defenders.

Training

Special health and safety training is required to be able to carry out welding and thermal metal cutting and associated grinding work. The same training requirements apply to operators of welding and cutting machines that may give off smoke.

The training must be approved by the Ministry of Education and will be widely available. It is the employer's responsibility to ensure that the work is only performed by persons who are in possession of a training certificate or a letter of recognition from the Danish Working Environment Authority. Please note that foreign training certificates or qualifications must be recognised by the Danish Working Environment Authority before work commences.

Gloves

Wear gloves when welding. These will protect you from radiation or burns from the welding flame.

If welding in a kneeling position, use knee protectors/pads and suitable ankle sleeves and apron to protect against sparks and glowing metal drops.

Eye protection



Wear a welding helmet, hand screen or suitable goggles with side protection if you are going to weld or are working near to the welding site. Use the right type of filter glass in welding helmet, hand shield or suitable glasses. Using a fixed or moving screen where the density is the same as in the protective glass is even better. Be aware of people in the same area as they may also be exposed to sparks and welding light.

Light from welding/photo-ophthalmia

Light sensitivity, watery eyes, swollen eyelids and severe eye pain are typical symptoms of "welding eyes". If you experience these symptoms, you should contact your doctor quickly. Your doctor may prescribe medicine that will help and also tell you how to use the medicine.

Consider all this when the company is to carry out its workplace assessment and obtain any advice from an ophthalmologist before work is commenced.

Risk of fire

Inflammable objects must be removed from the welding site. If you need to weld near to inflammable materials which cannot be removed, you should have both a person on watch and a fire extinguisher. If necessary, use shielding between the welding site and the flammable substances.

Check neighbouring rooms which are linked via pipes to the room where welding is taking place. Also check whether any fire would block escape routes. Always carry out a final inspection when you have finished welding.

Electric welding

Do not touch conductive objects which are often found between pipes, behind containers, etc. Damp soil may conduct electricity. Therefore, be particularly careful if you are wet due to rain or sweat.

When welding:

- Use complete and dry welding gloves, also for your assistant if necessary. Only touch the electrode with insulating gloves.
- Do not place the electrode between arm and chest when replacing it.
- Do not place the welding cable over the neck or arm.
- Keep your work clothes dry and intact. Replace damaged welding equipment immediately.

If there is a risk of the body touching conductive parts, e.g. in boilers and containers, requirements for the welding apparatus as follows:

- The open circuit voltage must be reduced to 12 V a.c. or converted to a maximum of 100 V d.c. voltage within 0.2 sec. after the arc has been switched off.
- A monitoring device must be in place to check the protection.

Gas/oxyacetylene welding

Checklist for gas welding (oxyacetylene welding):

- Secure the steel cylinders against blows, knocks, tipping or heat.
- Store them away from sunlight and rain.
- Store filled and empty bottles separately.
- With empty bottles, the cylinder valve must be closed and the protective cap attached.
- Gas and oxygen hoses must be intact and have no joints.
- Bottle valves must not be lubricated or subject to blows.
- Bottles with defective valves must not be used.
- Bottles are transported with a suitable transport trolley.

- Check whether the cylinders have been examined periodically. The date of the next inspection will be stamped onto each individual cylinder.



TIG welding

During TIG welding, ozone is formed in a dome around the arc at a distance of up to one metre.

Ozone, which is hazardous to health, can only be captured effectively by means of low pressure extraction, which has a much greater capture zone than high pressure extraction.

Please note that carcinogenic particles are also developed during TIG welding and must be removed by effective process ventilation.

You must be protected against splashing and optical radiation by a helmet with loose neck protection, as well as gloves and protective clothing. The helmet must be fitted with self-darkening welding glass which automatically changes the imperviousness of the welding glass when the arc is struck.

Self-darkening welding glass reduced the risk of photo-ophthalmia as this prevents the effect that may arise if the helmet is closed too late once the arc is struck. Also, set up screens to protect your colleagues from direct and reflected optical radiation.

8. WORK PROCESSES

At high current strengths and when welding aluminium, the ozone is formed so far away from the arc that low pressure extraction has problems capturing the ozone effectively. Therefore, in this situation low pressure extraction must be combined with the use of suitable respiratory protection to counter ozone.

Respiratory protection equipment with turbo unit (turbo mask) is only accepted by the Working Environment Authority if the mask, including filter, is suitable for the specific welding process, cf. the manufacturer's instructions.

Oxygen

Oxygen cylinders must be regulation blue with white shoulders. Cylinders, pipes and devices must not come into contact with oil or other greases as this may cause spontaneous combustion.



Acetylene (gas)

Acetylene cylinders must be of a regulation red-brown colour. Acetylene is highly explosive. Never use any cylinder with a leaky or defective valve. The cylinder should remain upright when in use. To prevent blowback in the acetylene cylinder, a blowback safety valve should be fitted at the pressure relief valve. Blowback or strong heating may cause the cylinder to explode.

Lodning og flusmidler

During heating, most fluxes give off unpleasant vapours (often acid vapours) which are harmful to health. These vapours must be removed by extraction before they reach your nose and mouth. Flux agents and solder metals must not contain more than 0.1% cadmium due to the risk of poisoning. A chemical risk assessment must be carried out.

LASERS

Laser radiation - both direct and reflected - may cause injuries to the eyes and skin. Lasers are divided into classes according to how dangerous they are, with associated safety arrangements. These are class 1 and class 2, where the ordinary blinking reflex of workers will normally prevent injury, and class 3 and above where special arrangements have to be implemented.

Classification of lasers and the associated safety arrangements must be compliant with European standard EN 60 825-1. When delivered, the laser must have Danish instructions for use and be provided with a warning sign.

Lasers may only be used by people who have the necessary knowledge and have received instructions on how to use them. To avoid hazardous radiation, all personnel in the area in which the laser is used must be aware of the safety arrangements.

When work is being carried out using a laser, a warning sign must be placed in an appropriate place and be visible to all.

Other safety rules:

- Never look into the laser beam.
- Always use a beam stop.
- Avoid dangerous reflections from shiny surfaces and work tools.
- Avoid the use of measuring instruments with binoculars.
- Position instruments so that the laser beam cannot be detected.

8. WORK PROCESSES

- When not in use, turn the laser off.
- Do not use a laser of a higher grade than necessary.

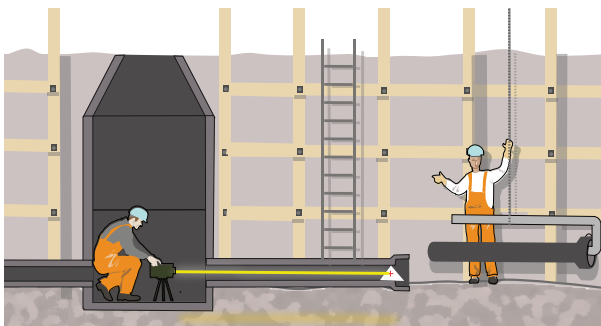

MENTAL HEALTH

The psychological effects of work can lead to increased absence due to illness, deterioration of mental health, poor well-being, conflict or employees leaving the company.

It is particularly relevant to focus on the following three risk factors in the industry:

- High workload and time pressure
- Traumatic events, e.g. serious occupational accidents, violence and threats
- Offensive actions, including bullying and sexual harassment.

High workload and time pressure

High workloads and time pressure can arise or deteriorate due to lack of, or poor planning, especially in relation to the coordination between different professional groups, who must work in close proximity or consecutively. High workloads and time pressure can be prevented through good planning at all levels. The developer, project design engineer, contractor, master craftsman, employee and team have an influence on good planning. Check the health and safety plan and address the issue at start-up meetings and safety meetings if it is believed that the heavy workload and time pressure are due to poor coordination and planning at the construction site.

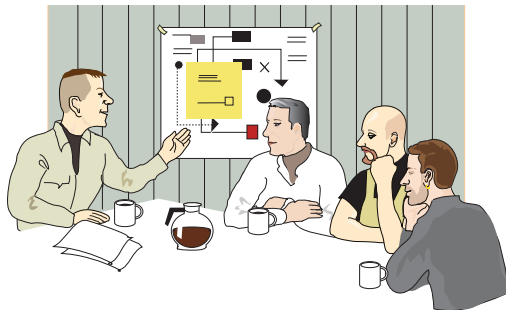

Employees' influence on how the work is to be performed can have an impact on both time pressure and job satisfaction. It is important that employees contribute to discussing the volume of tasks in order to avoid too much time pressure and to ensure that the skills match the task. Influence can also be about the choice of methods, so that work processes that are potentially harmful to health can be avoided.

Employees working alone are particularly exposed if they work under time pressure or if there are large volumes of tasks. Employees should always be able to contact a manager or colleague. This enhances security and may prevent stress. If due to time pressure, you are not particularly good at using technical aids, tidying up or continually ensuring that the safety measures are updated, etc., there may be an increased risk of accidents.

Training and instruction are also important in preventing heavy workloads and time pressure, just as they are important in preventing accidents. It is important that all employees are familiar with the handling of materials, machines and tools to be used for the task. Foreign and new employees may need more instruction than Danish employees, just as they may need more support from their Danish colleagues.

Traumatic events

Unfortunately, the frequency of accidents remains high in the building and construction industry and there is therefore a distinct possibility that employees or managers may witness a serious accident or be exposed to an accident themselves. It is therefore important that the company is able to take care of the employees who have experienced this and who may be seriously psychologically affected by it. If there is a risk of traumatic events, the rules require that companies must have measures for psychological first aid, just as there must be a contingency plan for the handling of the actual accident.

Psychological first aid is a general human aid in managing an unpleasant and traumatic experience. One or more persons in the company must be appointed to provide psychological first aid if and when needed. These persons must have the necessary training and

possess the appropriate equipment, e.g. means of transport, telephone, etc. Employees in the company must be informed of the measures concerning psychological first aid, and the company is responsible for determining the content of the measures, possibly via the company's working environment organisation.

The person (s) responsible must be able to:

- calm the injured person down, take control and maintain an overview
- listen attentively, calmly and patiently to the injured person's description of the experience
- attempt to allay the injured person's tendency to blame themselves
- ensure that the injured person does not drive home alone in shocked or under supervision
- notify the next of kin of the injured person about the incident
- agree with the injured party on the next few days and weeks.

If the employees are very shocked, there may be a need for actual crisis help as follow up to the psychological first aid. Many companies have a health scheme covered by a collective agreement in which employees can receive free psychological counselling by phone; this can be done anonymously and independently of the workplace. Or you can get help from a professional crisis psychologist.

Offensive behaviour - including bullying and harassment

Offensive behaviour in relation to the work can take place regularly, over a longer period of time, or be individual offensive behaviour. Bullying is defined as offensive behaviour that takes place regularly and over a long period of time or repeatedly in a serious manner, where it targets the same people who perceive the behaviour as hurtful or degrading. Offensive behaviour only becomes bullying when the people it is directed at are unable to defend themselves effectively against it. The victims' experience of the offensive behaviour is important for understanding the nature of bullying. In this context, it is irrelevant whether the behaviour is an expression of unconsciousness

or a definite desire to violate the victim. It does, however, affect the victims' experience of the bullying whether it is a matter of malicious will or not.

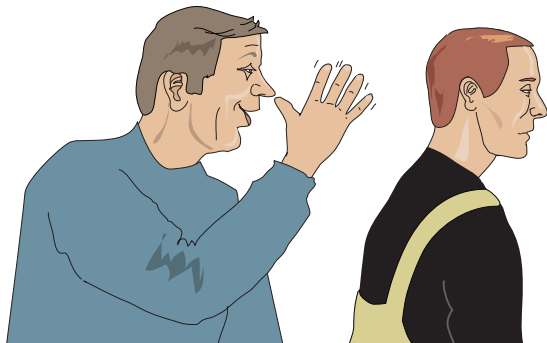

Teasing that is perceived by both parties as benign or individual conflicts are not bullying.

Sexual harassment is a particular form of offensive behaviour in the form of unwanted sexual attention, such as unwanted touch and unwanted verbal encouragement to sexual intercourse.

Bullying and sexual harassment can occur at any workplace. Management should therefore express clear attitudes towards bullying/sexual harassment. For example, the company can formulate a clear policy to prevent bullying and sexual harassment. A personnel policy with emphasis on openness and communication can help to prevent bullying and sexual harassment. It may, for example, include action plans for prevention, possible complaints, handling of complaints, etc.

Seek simple and practical solutions. Make bullying a problem that touches everyone at the workplace and not just a problem between the bullies and the bullied. Consider the problem in the working environment group/working environment organisation and discuss how to solve the problem specifically.

Well-being

The psychological working environment is about much more than the rules. Everyday job satisfaction is essential for an individual's experience of whether his or her working day is good or bad.

Effective cooperation, with openness and communication, are very significant when it comes to creating a positive sense of community within the enterprise and to prevention of conflicts.

Respect and fairness are important elements in both the company and on the construction site. Ordinary good communication and involvement of employees' views are important prerequisites for good cooperation.

Construction companies often have to deal with new colleagues. A good reception culture in the company and at the construction site helps to ensure that new colleagues are well received. This applies to new employees, including foreigners, young people and apprentices, who are thoroughly familiar with the working conditions and what is expected of managers and employees in order to maintain good health and safety conditions and constructive forms of cooperation.

In established teams, there may also be cooperation problems that should be solved before they develop into actual conflicts. This can, for example, be solved by reorganising the crews in such a way that everyone thrives with their closest colleagues and managers.

GENERAL INFORMATION ON PERSONAL PROTECTIVE EQUIPMENT

Personal protective equipment is safety helmets, respiratory protection equipment, etc. that protects employees during work. See the drawing.

Personal protective equipment is a last resort

As a rule, work environment problems should be resolved without the use of personal protective equipment.

- Can substitutes be made for less hazardous substances?
- Are there technical measures that remove or minimise the impact, e.g. encapsulation and process ventilation (extraction) or other measures where safety will be just as good?
- Can the number of employees be minimised by separation of workplaces or job rotation?

If this is not possible or the level of protection is not high enough to protect the employees, personal protective equipment must be used.



For example, if an adhesive containing solvents is to be used, check:

1. That the adhesive can be replaced with a less hazardous one, e.g. a water-based adhesive.
2. If not, effective process ventilation (extraction) must be provided.
3. If this cannot effectively protect you from inhaling solvents, you must also use suitable respiratory protection.

Requirements for protective equipment

Protection: Make sure that the item of protective equipment offers the necessary protection. **Respiratory protection equipment** must have filters suitable for the task at all times providing adequate protection. **Respiratory protection** must have the right filters. It is also essential for protection that respiratory protection is suitable for the person using it and fits closely to the face.

Discomfort: Protective equipment must not cause more discomfort than is necessary to allow it to work. Example Not everyone can wear the same footwear, so just having one type to choose from is not enough.

Suitability: Protective equipment must be suitable for the task at hand. Example If you do work where there is water at or in an excavation, for example, you must use safety rubber boots and not safety shoes.

Protective equipment must not have more properties than is necessary, as additional properties may cause unnecessary inconvenience.

Delivery, payment, maintenance and ownership

It is the job and responsibility of the employer to ensure that employees are given the right protective equipment. The employer is also responsible for cleaning and maintenance.

The employer pays for and owns the protective equipment and can therefore demand that the employee leaves the protective equipment at the workplace at the end of the working day, as well as after termination of employment.

Responsibility for protective equipment

The employer is responsible for:

- to ensure that employees use protective equipment during work
- to train and instruct in the use of the protective equipment and to ensure that employees follow the instructions
- explain to employees the consequences for health and safety if instructions are not followed
- to supply suitable protective equipment where necessary and is appropriate for the person using it.

employees are responsible for:

- using the protective equipment from the start of the work until it has been completed
- informing the supervisor or employer if there are defects or deficiencies in the protective equipment

Limits for use

Using protective equipment may cause discomfort and make it necessary to limit working time, for example, by including breaks. This also applies to the use of respiratory protection equipment, where some types have a fixed limit for how long they may be used at a time.

Usage instructions and labelling

The supplier must ensure that instructions for use are always included when supplying personal protective equipment. Before using the protective equipment, you should familiarise yourself with the instructions for use and how to use the protective equipment.

10. PROTECTIVE EQUIPMENT

The instructions for use must be in Danish and written in clear, comprehensible language. If foreign employees are employed, or employees who do not understand Danish, the instructions for use must also be in a language understood by the employees.

The instructions for use must include information on:

- how to use the protective equipment
- storage, use, cleaning, maintenance, repair and disinfection
- resistance determined by technical testing,
- which accessories can be used with the protective equipment
- restrictions on the use of the protective equipment
- the day the protective equipment loses its shelf life
- suitable packaging for transporting the protective equipment;
- the meaning of any labelling.



Personal protective equipment and accessories must be CE marked by the manufacturers.

HELMETS



If there is a risk that your head may be injured during your work and this cannot be counteracted by other means, you must always wear a protective helmet. protective helmet

- Materials, tools or other objects that tip over or fall
- Objects protruding or heavy materials or equipment hanging or swinging
- Uninsulated electricity cables
- Confined spaces that make it difficult to move without bumping into walls or objects

Always wear a helmet when a sign indicating a helmet enforcement notice is displayed.

Choosing a protective helmet

A suitable CE-marked safety helmet manufactured in accordance with standard DS/EN 397 must be used for building and construction work. It is stated in the manufacturer's instructions for use what each helmet is suitable for.

The special conditions at the place of work generally determine which helmet is to be worn. For example, if there is a risk of getting your head trapped, you must choose a helmet which specifically protects against this.

The colour and shape of the helmet must sometimes be suitable for the job function, e.g. the hook's helmet should have a bright colour that makes it easy for the crane operator to see.

It is important for the helmet not to weigh more than necessary.

When working in cold surroundings, you can wear a hat under the helmet, fit it with an insulating cover or insulate it inside.

Helmets with chinstraps must be worn if there is a risk of the helmet falling off, e.g. due to a special working position or windy weather.

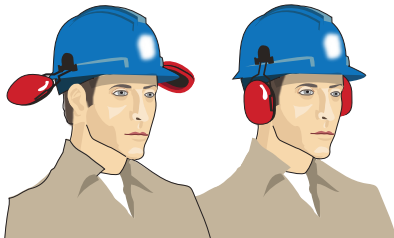

Only use equipment which fits the helmet. This ensures that the protective properties are not destroyed. Helmets which are to be used together with respiratory protection, ear defenders or eye protection must be suitable for the purpose.

Adjustment and maintenance

Helmets must be discarded if they are cracked or have been subject to strong blows or been trapped.

Helmets must sit firmly on the head, and there must be a suitable safe distance between the outside of the helmet and the head.

The helmet lining is subject to perspiration, dirt and heat and so breaks down more quickly than the outside of the helmet. The inside lining must therefore be checked regularly and always replaced in accordance with the supplier's instructions, but no later than when it shows signs of wear and tear. Always discard the lining if you are in any doubt.

Durability

Helmets must not be painted/sprayed or cleaned using solvents as this may weaken the helmet. Cold, heat, strong light, moisture and perspiration can also weaken the helmet's ability to provide protection if it is subjected to such for any length of time. The same is true for any products used on the skin or hair.

Information on the properties of the helmet after long-term use is available from the supplier. Shelf-life is normally five years after use in normal conditions and storage and if there is no damage to the helmet. Information on shelf life must be stated in the instructions for use. Production year and month are often stamped into the helmet. Helmets should not be stored in sunlight when not in use.

EAR DEFENDERS

Requirements for the use of ear defenders

Ear defenders are not a permanent solution to noise problems. The company must continuously assess the conditions with a view to finding other technical or organisational measures to replace hearing protection.



If the employer is of the view that employees are exposed to risks as a consequence of noise, the workplace assessment must include an assessment of the noise load. Measurements are carried out insofar as this is necessary in order to clarify what loads are involved.

Measurements can ensure correct assessment of whether ear defenders should be used. A rule of thumb is that if two people with one metre between them can only understand one another when they shout, ear defenders must be worn, unless the noise load can be reduced in some other way.



It is the employer's responsibility to provide suitable hearing protection for employees if the noise level exceeds 80 dB (A), or the peak values of impulses exceed 135 dB (C), and if the noise level is harmful or highly irritating.

Personnel must wear ear defenders if it is not possible to eliminate the noise load or reduce it to below 85 dB(A). The same is true if the peak values of impulses cannot be brought below 137 dB(C). Even if the noise load is below 85 dB (A), ear defenders must still be worn if it is assessed that the work may damage hearing.

BFA Building & Construction always recommends the use of ear defenders between 80 and 85 dB (A) to ensure that hearing damage is not sustained.

Ear defenders must be worn at all times in a noisy working environment. Even a short time without ear defenders in noisy surroundings can cause significant hearing impairment.

Ear defenders in general

Ear defenders must be CE-labelled. The packaging and usage instructions must include attenuation values at various frequencies.

This makes it possible to assess which ear defenders reduce noise best in relation to the actual work.

Hearing protectors must dampen as much as possible, but the user must be able to communicate with the surroundings and hear warning signals.

The attenuation should therefore not be greater than the user can still hear what is happening in the surroundings, i.e. the noise should be attenuated to a level of approx. 75-80 dB (A).

10. PROTECTIVE EQUIPMENT

If several different types of hearing protection meet the requirements, employees can choose the hearing protection that suits them best.

A slightly higher level of protection can normally be achieved by combining different hearing protectors, e.g. ear plugs and ear muffs. This means that the earplugs continue to offer protection when the earmuffs are removed.

Earplugs

Single-use or multiple-use earplugs are available. Most types can be shaped and so be made to fit different people's ears.

There are also moulded ear plugs in various types, which are manufactured according to the user's individual dimensions.

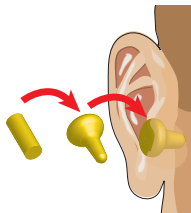
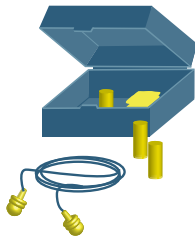

Only touch earplugs with clean hands as dirt in the ears may irritate the skin and cause eczema.

Earmuffs

Earmuffs are ear defenders which enclose and cover both ears and are kept in place by a strap or headpiece which can be adjusted to fit the head. They must fit tightly.

The sealing rings (pads) on earmuffs should be regularly checked and replaced as soon as they start to go stiff or disintegrate.



Earmuffs that can be fitted to helmets are available. You can also get earmuffs with built-in electronics or filters which ensure that the sound inside the ear defenders is restricted and regulated. Electronic muffs or muffs with filters have the advantage that they only dampen when the noise reaches a certain level (75–80 dB (A)).

EYE PROTECTION



Õjenvarm
pábud

Eye protection can be protective goggles, faceshields or welding helmets. You must always wear eye protection when working or entering places where there is a risk of being struck by flying particles or spatter, or if you are exposed to corrosive gases and vapour or harmful radiation.

The eye protection must remain in place without pinching.

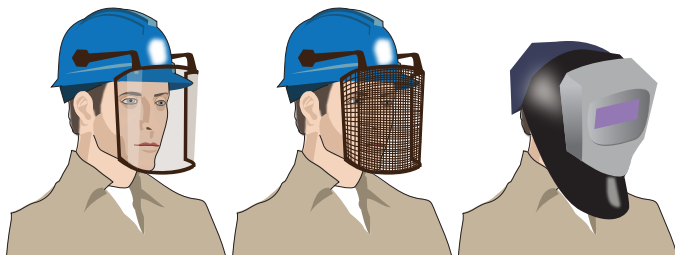

If an airtight eye protection is needed, it must be treated so that it does not fog.

Using the eye protection with respirators or other personal protective equipment must not impair overall protection. Eye protection must sit firmly without arms or headband pinching or cutting.

If you need airtight eye protection, this has to be treated so that it does not mist up. If glasses are already used, the eye protection must be large enough to fit the glasses. Alternatively, protective glasses with strength can be used.

Protective glasses



RESPIRATORY PROTECTION

There are three main types of respiratory protection:

- Respiratory protection with filtration and breathing resistance
- Respiratory protection equipment with turbo filter without respiratory resistance
- Respiratory protection with an air supply.

In the case of filtering respiratory protection equipment, the inhaled air is drawn through a filter. There are lots of different types.

Respiratory protection with an air supply supplies air from uncontaminated areas or from cylinders. This type should be used when:

- you must be protected against heavy contamination
- you use products with high code numbering (MAL code)
- you do not know the composition of the contamination, or
- if there is a risk of lack of oxygen

All types of respiratory protection equipment must be worn from the start to the end of the work.

Whether to use a full mask or a half mask depends on the work to be performed. Also consider using glasses, helmets, ear defenders, etc.

Respiratory protection must sit closely against your face.

The durability and degree of protection of respiratory protection is entirely dependent on strict adherence to the supplier's instructions

for use, which must follow and be written in Danish. If foreign employees are employed, or employees who do not understand Danish, the instructions for use must also be in a language understood by the employees.

The instructions for use provide information on how to use, store, clean, maintain, repair and disinfect the respirator.

Restrictions in working hours

It is particularly stressful to work with filtering respiratory protection equipment that puts a strain on breathing. This is why there are restrictions for the amount of time this protection can be used. Be sure to adhere to these, as your circulation (heart) may be particularly strained.

If a filtering respirator without turbo unit is used, it must not be used for more than three hours a day. If you need to work for more than three hours, you must use either respiratory protection with a turbo unit (fan) or respiratory protection with an air supply.

As working with respiratory protection is always stressful, irrespective of type, work periods using respiratory protection must be restricted by taking suitable breaks. During these periods, other work may be done that does not require the use of respiratory protection.

Work using respiratory protection with an air supply or turbo units should be limited to six hours per day, including appropriate breaks. For internal demolition work with asbestos, this is further reduced to a maximum of 4 hours per day - with rest breaks no later than after 2 hours of uninterrupted work.

Minors under 18 may only work three hours a day with respiratory protection with an air supply, and only when this is a necessary part of their vocational training.

Respiratory protection with filtration

Filtering respiratory protection equipment against dust and aerosols can be used.

Aerosols:

- Free movement
- Easy solution for individual tasks and work at changing workplaces.

Issues:

- Does not protect against all substances
- Limited durability
- Can only be used three hours a day if it puts a strain on breathing.



Filtration respirator Half mask with dual filter



Filtration respirator full face mask

Respiratory protection with filtration is available as single-use masks or full and half masks with particulate filters which can be replaced. There are different types of filter:

- Class P1 provides limited protection against dust. Do not use at limit values below 5 mg/m^3 . Provides no protection against asbestos fibres and quartz dust.
- Class P2 protects against most types of hazardous dust. These filters can provide protection against solid particles or against solid particles and liquid aerosols. If the filter is tested in accordance with EN149, the filter protects both solid particles and liquid aerosols, e.g. spray mist. Provides no protection against bacteria and viruses.

- Class P3 protects in the same way as class P2, but also protects against radioactive dust, bacteria, viruses and nanoparticles.

Dust filters provide no protection against harmful gases or vapours.

Respiratory protection equipment with filter

Full or half mask with gas filter which can be replaced. There are different types of filters and they are divided according to the ability to absorb gases, vapours and dust:

- Filter type A protects against mineral spirits, toluene, xylene and butyl acetate and other vapours from organic solvents with a boiling point of at least 65 °C.
- Filter type AX protects against vapours from organic solvents with a boiling point below 65 °C. These filters must be discarded on the same day as they were used.
- Filter type B protects against chlorine and cyanine and similar gases.
- Filter type E protects against sulphur dioxide and similar gases.
- Filter type K protects against ammonia and similar gases.
- Filter type Hg-P3 protects against vapours from mercury and particles.
- Filter type NO-P3 protects against nitrous gases and particles.
- Filter type SX protects against special substances.

The filters are available in various classes:

- Class 1 are low capacity filters.
- Class 2 are medium capacity filters.
- Class 3 are high capacity filters.

Respiratory protection equipment and gas filters that protect against the gas and vapours to which you are exposed must be used.

Some filters provide protection against several types at the same time. This will be indicated by the fact that there are more letters on the filter.

Two filters must be used to protect against both particles and gases at the same time. A suitable dust filter outside and a gas filter inside.

10. PROTECTIVE EQUIPMENT

When spraying etc., it is also a good idea to use a pre-filter to protect the particle filter.

Labelling

Particulate filters (dust filters) are labelled P1, P2, P3 and have a white colour code.

Gas filters are labelled with their type and class and also have a colour code:

- Brown for A filters
- Grey for B filters
- Yellow for E filters
- Green for K filters

Filters for several different gases and combinations of particles and gases are colour coded for each individual type.

Pollution	Class	Filter type	Colour code	Protects against
Particle	P1	S/SL	White	Dust (to a limited extent)
	P2	S/SL	White	Harmful and toxic dust. Solid particles or both solid particles and liquid aerosols
	P3	SL	White	Harmful and toxic dust, radioactive dust, bacteria, viruses. Solid particles and liquid aerosols
Gas	Cl 1 Cl 2 Cl 3	A	Brown	Vapors from organic solvents with a boiling point above 65°C
		AX	Brown	Vapors from organic solvents with a boiling point of 65 °C or less
		B	Grå	Chlorine, cyplaques and similar gases
		E	Yellow	Sulphur dioxide and similar gases
		K	Green	Ammonia and similar gases
		Hg-P3	Red-white	Vapours from mercury and particles
		NO-P3	Blue-white	Nitrous gases and particles
		SX	Violet	Special substances

Turbo respiratory protection

A turbo respirator (with fan and battery) draws the air through a filter (filtering respirator) which is blown into the mask/hood. There is therefore no respiratory resistance, and so the respiratory protection can be used for up to six hours in a working day.

Turbo filter respiratory protection equipment must only be used where ordinary filtering respiratory protection equipment can normally be used. It must therefore not be used if the MAL code requires fresh air respiratory protection equipment, such as when working with styrene.

Breathing with a turbo mask is easier and you are usually more mobile than using a standard air respirator. Select types with the greatest possible air capacity. This helps to prevent the visor from misting up, and it increases the actual protection offered by the mask/hood as it creates overpressure inside it.



Air supply to respiratory protection equipment

Always use respiratory protection with an air supply:

- when oxygen deficiency (oxygen concentration below 17% oxygen in the breathing air) may occur
- when there is air pollution in high concentrations
- when the air pollution is unknown or too large
- when there is no suitable filter
- when the mask cannot seal tightly
- when the work lasts more than three hours in total
- when work is heavy and breathing is difficult
- when required by working environment legislation, e.g. when working internally with asbestos or working with styrene or other equipment with high code numbering (MAL code)

10. PROTECTIVE EQUIPMENT

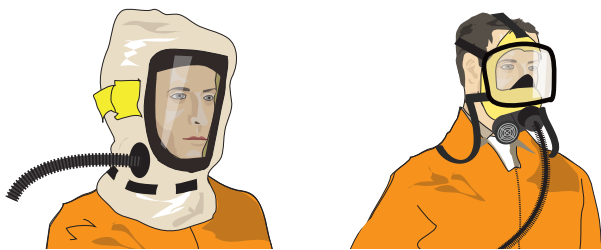

Always ensure that clean air is supplied from a non-contaminated area when using breathing apparatus with an air supply.

Protection factor

A protection factor (class 1, 2 or 3) describes how well a respirator can reduce the concentration of a harmful substance in the breathing air. The protection factor specified by the manufacturer is determined by means of laboratory measurements.

Actual protection in the workplace depends on several factors, including the degree to which the mask fits tightly to the face. Many dust masks do not fit tightly enough to the face. It is also a good idea to create a PSS when working in the vicinity of areas with heavy traffic (roads and railways). This includes many disposable masks.

The protection factor can be reduced if you have a beard or wear glasses. You may need to wear respiratory protection with an air supply with an overpressure hood or turbo unit.

Replacement of the particulate filter (dust filter)

Read the supplier's usage instructions.

When buying turbo filter respiratory protection, a test kit is often included for checking the filter. The service life of the filter can also be extended by using a prefilter.

In the case of general respiratory protection with filtration (with respiratory resistance), the rule of thumb is that the filter must be replaced when respiratory resistance increases noticeably.

Gas filter replacement

Read the supplier's usage instructions.

A gas filter can only absorb a certain amount of air pollution before it should be disposed of. There must be at least the same number of working environment representatives and supervisors within the working environment organisation.

When the filter needs to be changed, in addition to the service life, also depends on how the filter has been stored when not in use. The employer must provide information how long each filter can be used for and how to store it when not in use. For example, you can create a logbook for the individual filter and note how long it has been in use/out of the packaging. You can then change the filter in time.

If there is a smell of gas, it is too late to change the filter unless the smell is due to the mask not being tight. In both cases, you will need to get out into fresh air as quickly as possible. Therefore, change the filter well in advance of the end of its service life.

It is important to know if the gas can be smelled at all.

If a filter's service life is not specified, it must not be used.

Signage



Signs must be used to indicate work sites where respiratory protection must be used. The sign should be supplemented with information about the type of respiratory protection equipment to be used.

Signage is particularly important on construction sites where several companies work at the same time, so that other companies' employees are warned against entering the area where respiratory protection equipment is to be used.

FALL PROTECTION



If there is a risk of falling, proper arrangements must be put in place to prevent this. This can be done by fitting guard rails, setting up scaffolding, establishing barriers or hanging up safety nets, for example. Work can also be organised differently, for example, so that it can be done from a personnel lift with a working platform.

For short-term work on roof (max. 4 man-hours) or where it is not possible to establish other collective protection, personal protective equipment in the form of fall arrest equipment can be used.

If fall arrest equipment is used, it must be used in accordance with the supplier's instructions.

- Select equipment suitable for the task.
- Choose fall prevention equipment rather than fall arresting equipment.
- With fall arresting systems a lanyard with energy absorber must always be used to reduce the force of a fall.
- The anchor point must be capable of absorbing a dynamic load of at least 12 kN (1200 kg).
- With fall arresting devices, a person who has fallen and is suspended from the lanyard must be able to be rescued quickly.
- The stop length of the selected equipment must be calculated according to task and surroundings. Calculate the stopping distance according to the supplier's instructions.

Fall prevention equipment

Fall prevention equipment is used where harnesses/belts and lanyards must be prevented from coming close to edges and holes or working in certain lift types/platforms with man baskets. It can be used if the work is carried out less than 2 m from the edge and no railings are installed.

Fall prevention equipment is used, e.g. in connection with:

- element assembly
- roofing if the work is short-term
- scaffolding
- demolition
- thatching if the work is short-term
- setting up and dismantling security measures
- repair and service tasks from work baskets
- work from certain types of lift, etc.

Fall Arrest Equipment

Fall arrest equipment must be used if working in a place where there is a risk of falling to a lower level. Here, harnesses and lanyards with energy absorbers must be used, which brake the employee in the event of falling. The anchor point for the person must be able to absorb a dynamic pull of 12 kN, which corresponds to approx. 1200 kg - and must, as far as possible, be positioned above the person.

Fall arrest equipment can only be used when there is sufficient clearance below the work site. This means that the total stop length includes an extra length of 1 m (safety distance), which gives an extra safety margin. It is very important that this calculation is made for each type of equipment, for each employee and for each work situation, as it may vary from situation to situation. For example, different types of equipment often have different line lengths and braking distances. This must be stated in the manufacturer's instructions for use.

Fall prevention equipment is typically used in connection with short-term tasks on roof surfaces and at heights where collective safety measures cannot be established and where there is a risk of falling.

When fall arrest equipment is used, an emergency response plan for rescue in the event of a fall, including use of rescue equipment, must be prepared, as injuries to a suspended person can quickly occur. Rescue procedures and safe rescue methods must be specified in the contingency plan, in which personnel must be trained and instructed before using the equipment. It is important that the employees have been trained in carrying out the emergency procedure so that it works in the event of falls/accidents.

Checking and inspection

Checks, including inspection, maintenance, use and storage of fall arrest equipment must be carried out in accordance with the individual suppliers' instructions for use. Instructions for use in Danish must accompany the purchase of the equipment. If foreign employees are employed, or employees who do not understand Danish, the user instructions must also be in a language understood by the employees. Always check all individual parts before using the equipment - even if it is brand new:

- Catch arrangements and sliding systems must be clean
- There must be no wire breaks, cracks, visible wear and tear
- Do not write on the equipment with pens, etc.

Immediately discard the equipment or have it repaired if it has any faults which may impair its function. If the equipment has been used to prevent a fall, it must always be replaced.

The equipment must be inspected by a trained person at least once a year, and more frequently if the equipment is used a lot. Read the usage instructions if the equipment is to be checked more frequently. The equipment must be labelled with the date of the last inspection.

Fall protection equipment will remain usable for the longest time if it is stored clean, dry and protected from daylight. Metal parts must not be allowed to rust. The equipment will normally not last more than five years.

Harnesses

Harnesses must catch people who are falling. It is important to ensure that the line is attached to the harness in such a way that the person falling will hang vertically after falling.

The harness must be adjusted to fit the user, and loose clothing beneath the harness should be avoided.

If there is a risk of free fall, a full body harness and fall damper must be used.

Use a harness with a line to raise or lower personnel:

- when working in containers with narrow openings
- when working in deep wells or silos

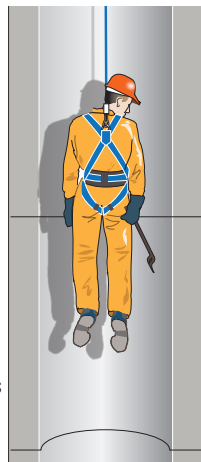

Support belts/harnesses

If you need to be able to use your hands at work, for example when working with masts, it is a good idea to use a support belt that limits your working area so that you cannot overbalance (fall prevention equipment).

A support belt should not be used where free fall may occur. If there is a risk of free fall, use an H-belt and fall breaker.

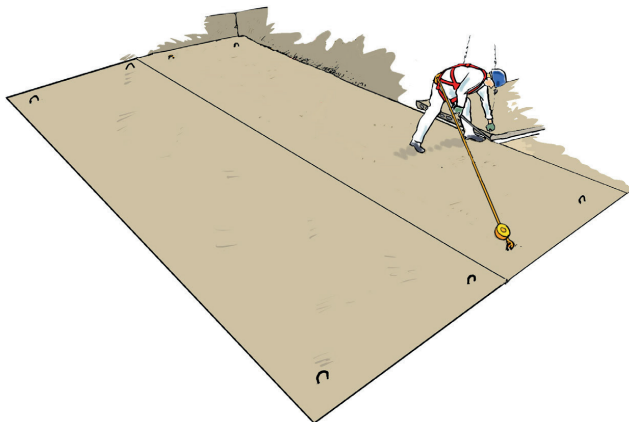

Lines

The line which connects the harness to the rest of the fall protection equipment must be made of a synthetic rope, steel cable or rope.

The line must be as short as possible – including the energy absorber, coupling elements, etc.

Fall prevention wire system/running line

A wire system is a wire that is secured via anchor points, e.g. on a flat roof.

A 'slider' suitable for the wire which must be able to pass over the anchor points must be used.

The fall arrest device is connected to the wire and is the connection between the personal fall arrest equipment and the fixed system. The function of the slider is to be able to pass over the anchor points without having to be dismantled and to ensure that the attachment point is continuously as close to the work place as possible.

The fall arrester and the wire system must be approved assembled. Look for the CE mark and inspection label on the equipment.

When working on roofs with an existing fixed system, pay particular attention to whether there is:

- a clear sign indicating whether the system has been inspected and approved within 12 months.
- a sign describing how many users may work on the system at the same time.
- a "slider" approved for the system, which is also approved within 12 months.

It can be a good idea to place this sign on the door out to the roof or somewhere else visible.

Fall arrest blocks

The fall arrester (yo-yo) keeps the line tight while working, thereby minimising the fall as much as possible.

Fall arresters must normally always be placed above the person's head, but certain types/makes can be used on flat roofs if a number of measures are observed, which are specified by the supplier. In particular, remember that the necessary ground clearance increases significantly. Refer to the manufacturer's instructions for use.

Pay attention to whether a fall arrest device is integrated in the fall arrest device or whether an external fall arrest device must be fitted. Normally there should not be two lanyard with energy absorbers in a system.

Fall limiters

A lanyard with energy absorber reduces the force of a fall by absorbing part of the fall energy so that braking does not become too abrupt.

Fall limiters may, for example, include a line with an integral fall limiter or other form of energy absorber.

In fall arrest systems, a fall arrester must be used - and always only one! Please note that several systems have a fall arrester integrated.

Connectors, e.g. snap hooks

The individual parts of the equipment are typically connected using snap hooks or other connectors. These must be self-closing and be lockable, either manually or automatically.

It is important that you can operate it with one hand and open it with a maximum of two movements. Do not use a manual lock if you have to lock and unlock the device several times over the course of a working day.

Always use an approved anchor point for your fall arrest device. Do not use installation pipes, radiators, etc. as they are unsuitable.

The anchor point must be able to absorb the force generated if a person falls. This corresponds to a load of 12 kN (1200 kg). The line, rail, etc. must not be able to come loose from the anchor point. Spot checks may be required. The anchor point should ideally be located above the place of work and not too far out. This ensures the shortest free fall.

Signage

Work areas where fall protection is used must be marked with mandatory signs. This means that there must be no doubt as to whether fall arrest equipment is mandatory when working in specific areas/work processes. This will typically apply to stairway and access areas, e.g. stairs in element building) to the areas/work processes where fall protection equipment is mandatory. However, there may be cases where the work is so spread out that signage is not practicable. If there is a risk of falling objects and/or tools, this must be prevented using screens or by cordoning off the area below.



Beveiligingskleding
pálbuudt

PROTECTIVE CLOTHINGJ

Protective clothing can, for example, be arm guards, coveralls, etc. that protect against chemicals or cold.

If the suit is to protect against chemicals, it is necessary to know how long it will take the specific chemical to penetrate the suit, i.e. the breakthrough time. This determines how long you can use it.

Look for the breakthrough time of the suit in the instructions for use or on the label. Or ask the supplier.



Be aware of whether the suit has to provide protection against several effects at the same time, e.g, chemicals, temperature, wear, etc.

When using a chainsaw, you must wear trousers with a cut-resistant insert which effectively protects the front of the legs.

These are also described in connection with the individual items of machinery and tools in this manual.

You can wear a suit made of metallic woven textiles in strong heat. Before wearing protective clothing, it is important to check that it is fault-free.

10. PROTECTIVE EQUIPMENT

If work is to be carried out in traffic or other places where it is important to be seen, warning clothing must be worn (see section on road-works).

GLOVES



Hudbeskyttelse
påtødt

Avoid direct skin contact with harmful substances. Corrosives, solvents, bitumen and cutting oil are among the substances that are important to protect the skin from. Chromate, epoxy and isocyanate products, preservatives and nickel can all cause allergies and some can also cause cancer.

Choosing gloves

It is important that the gloves are suitable for the type of work to be performed. Ask the glove supplier which gloves are suitable for the work to be done.

It is the employer's responsibility to ensure that the right types of gloves can be used at the start of the work.

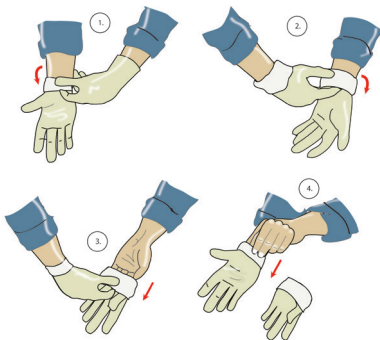

It is important, for example, to make sure that the gloves are the right size. If they are too small, they may impede the circulation and their ability to insulate against cold or heat may be reduced.

You can wear undergloves made of cotton to absorb moisture.

Remove the gloves as shown in the illustration so that the fabric does not touch your hands.

Protection against chemicals

Protective gloves can only keep out chemicals for a certain time until the chemical penetrates them. This is known as the penetration time. Be aware that this starts from the moment your gloves come into contact with the substance, even if the gloves do not appear to be dirty or contaminated.

One type of glove can have a good protective effect against one chemical, but not necessarily against another that looks similar. Be aware that mixtures of chemicals may sometimes have different properties to the ones you would expect, given what you know of the properties of the individual components.

Hazardous use of gloves

In some situations it can be dangerous to wear gloves, e.g. when working with rotating tools where the tool risks interfering with the glove and pulling the hand in.

Take care of your skin

When working with gloves, it is important to keep the skin's own barrier intact. Intact skin prevents the attack of bacteria, viruses and harmful substances. Therefore, use skin care creams during breaks and after working hours. Dry and tired skin should also be treated with cream. This will make your skin supple until it recovers.

How to protect the skin:

- Do not use substances that may irritate the skin or cause allergies.
- Prevent your skin from coming into direct contact with harmful substances or with workwear which is contaminated or soaking wet.
- Avoid soaps and creams with unnecessary additives such as perfume.
- Do not clean or wash your hands in any detergents that are stronger than necessary and avoid submerging them in water for any length of time.
- Watches, rings and jewellery should be removed before starting work.

PROTECTIVE FOOTWEAR



Võimefodilaj
pääbud

Wear shoes or boots with a steel hood if there is a risk of having your foot pinched or damaged by falling objects. For example, when you work with heavy and unwieldy objects, i.e. over 16-20 kg.

Here are a number of examples of work where protective footwear with toe protection must be used:

- Rigging
- Installation and removal work involving concrete elements, shuttering slabs or blocks, plasterboard and electrical cabinets.
- When working with drain elements, wells, district heating pipes, LECA blocks, roofing panels, doors, windows, kitchen units, white goods, washbasins, toilet bowls, bath tubs, radiators, oil-fired boilers and hot water tanks.
- When erecting and dismantling scaffolding.
- When positioning kerbstones and paving stones.

Footwear with protective soles must be worn when there is a risk of treading on pointed or sharp object such as nails and shards of glass.

In the building and construction industry, a combination of steel toe caps and protective soles is normally necessary.

In general, you should select your footwear according to conditions on the work site. For instance, is it cold and damp, and is the ground uneven, hard or slippery? Your needs will also vary depending on whether you move around while you work or stand still to work.

This means, for example, that it is best to wear footwear with an shock-absorbing sole and footwear that is properly attached if you are working on uneven surfaces, as is often the case on construction sites.

Protective footwear must also be suited to individual employees and their needs. Shoes or boots must remain firmly in place and fit well. This is particularly important for footwear with steel toecaps, which is unable to mould itself to the shape of the feet.

It is therefore good if the employee has the opportunity to choose between different types of footwear so it is possible to change - depending on the task at hand.

Protective footwear with a flexible sole and separate heel should be worn when working on ladders, stairs, reinforcement, etc.

A

access routes.....	24, 25, 27, 57, 61,63, 64, 65, 66, 88, 123, 131
accidents.....	55
Acetylene.....	186, 314
adhesives.....	208, 229, 238, 324
Adhesives.....	213
administer first aid.....	318, 319
Advantages:.....	212, 214, 242,334, 336
a health and safety plan is drawn up.....	24
air lines.....	112, 270
alarms.....	32, 221
allergies.....	204, 230, 232
alternating workplaces.....	231, 234
ambient humidity.....	264
ambulatory work.....	259
ammonia.....	335, 336
angle grinder.....	175
annual working environment discussion.....	35
application methods.....	207
APV.....	198, 199, 224, 235, 239
arthritis.....	192
asbestos.....	287, 288, 290, 300, 301
asbestos.....	9, 22, 34, 44, 69, 99
asbestos cement tiled roofing.....	222
as extra properties may cause unnecessary discomfort.....	324
asphalt.....	69, 216, 217, 218
asthma.....	231
attics and spaces under the eaves.....	300

B

back injury.....	51
bacteria.....	69, 334, 335, 336, 349
balance saws.....	168
balconies.....	86
bandsaws.....	165
basket.....	126, 151, 153
B certificate.....	120, 148
Before work begins:.....	303, 306, 311
belt grinders.....	174
bitumen.....	216, 217
Blade thickness.....	167
bogies.....	145
boundaries.....	24, 25, 31, 32
boundary marking.....	267, 275, 278,280, 284
bracing.....	140
broken stone ballast.....	144
bronchitis.....	231, 309
building hoists.....	149, 150
bullying.....	319, 320
butyl acetate.....	335

C

cab.....	148
Cable reels.....	96
cables.....	94, 95, 96, 97
Cables.....	84, 94, 237
cadmium.....	231, 315
Cancer:.....	183, 209, 213, 221, 231,309, 348
canteen.....	67, 69
carrying technique.....	253
caterpillar tractors.....	148
CE mark.....	156
cement.....	232, 233

Chains 76, 139
 chalicosis 230
 Chemicals 50, 51, 52
 Chlorinated paraffins 241, 288
 chlorine 335, 336
 circular saws 157, 166, 167, 176
 Classification and labelling 203
 closed rooms 301, 303, 304, 305
 clothing 244, 286, 347
 Code numbering 205
 Cold 99, 191, 262, 263, 328,
 347, 348
 Collision 275
 commissioning 106
 compensation 51, 52, 190,
 217, 328
 compressed air chisels 182
 compressed air cylinders 181
 compressed air-driven nail
 guns 180
 compressed air hammers ... 181, 182
 compressed air tools 182, 185
 concrete 165, 221, 229, 232,
 291, 295
 concrete precast panels 87, 219,
 252, 253, 292, 350
 concrete surface finishers 164
 Cones 76
 Connectors 346
 construction site switchboards 96
 construction work near
 to water 274, 275, 277
 Contact eczema 213
 containers 59, 74
 contaminated soil 197
 contract machinery 135, 136, 166,
 220, 245, 261
 contractor's machinery 190

Copper 231
 cordoning off 87, 225, 270, 281,
 283, 284, 340, 346
 Covers 113
 Crane baskets 128, 129
 Crane driver's certificate 136
 Crane operator 140, 141
 Crane rails 144, 146
 Cranes 134, 135, 138, 139,
 141, 143, 147
 Crawl spaces 256, 298, 299, 301
 crosscut saws 168
 Crossover harnesses
 with ankle ties 305
 cut-resistant inserts 172
 cutting oil 348
 cutting width 167
 cylinders 186, 312, 332

D

damage to the reproductive
 organs 209
 damage to the unborn
 child 209, 233
 danger of explosion 209
 dead man's control 162, 164, 169
 demolition 287, 289, 290
 developers 23, 24, 28, 30
 dinghies 276
 disc shatter 174
 district heating plants 305
 double lifting with cranes 134
 dowels 294
 drainage 27
 drains and waste water 242
 draughts 262, 263
 drills 173
 driver's seat 261

dumpers 148
 dust 219, 220, 221, 225, 228,
 229, 230, 231, 235
 dust filters 336
 dust masks 289, 338
 dust-repellent workwear 183, 225,
 228, 232, 289

E

ear defenders 328, 329, 330
 earmuffs 330, 331
 earplugs 330
 EASY 52
 eccentric grinders 174
 eczema 208, 211, 213, 216, 232
 Election of working environment
 representatives 19, 41
 Electrical groups 90
 electrical installations 92
 electric hoist 105
 electricity 92, 94
 electricity groups 90
 electric power chainsaws 172
 electric welding 312
 emergency preparedness 123
 emergency stop 161, 162, 169
 employees 9, 17, 21
 enclosed spaces 298, 299, 305
 enforcement notices 12, 13, 14,
 15, 18, 58, 251
 epoxy 213, 214, 215
 escape routes 64, 65, 66
 EU Machinery Directive 155
 excavation 267, 268, 283
 excavation work 265, 266,
 267, 270
 excavators 63, 95

excreta 243
 Executive Orders 9, 11, 15
 extension cables 97
 extension sockets 97
 extinguishing equipment 307
 eye damage 204
 eye protection 331
 eye protection 235, 239
 Eye protection must be sufficiently
 large and give clear vision so that
 you can work properly 231, 242,
 274, 309, 335, 336

F

façade scaffolding 103, 105, 107, 109
 fall arrest blocks 345
 fall limiters 345
 fall protection 340, 346
 fault current switch 96
 feed blocks 168
 filters 217, 225, 230, 244, 324,
 331, 334, 335
 first aid 55, 277
 flat roofs 76
 flint 229
 flow 266, 267
 fluxes 315
 fly ash 232
 foot boards 80, 81
 foot protection 323
 foot rails 110, 126
 fork lift truck 135
 form oils 211, 212
 frost 183, 266

G

gable ends.....	77, 80
galvanised.....	143
gas cylinders.....	204
gas filters.....	336
gas pipes.....	179, 273, 289
gas welding.....	312
glasses.....	175, 177, 244, 311, 332, 338
Gloves.....	348, 349
groove cutters.....	173
ground cables.....	272
guard rails.....	79, 80, 81, 83, 85, 87, 109, 122
guard stirrups.....	145
guides.....	10

H

hand boards.....	79, 80
handheld circular saws.....	176, 177
H and P phrases.....	204
hand rails.....	109, 115, 117, 121, 122, 126, 127
hand sweat.....	213
harassment.....	320
harbours.....	274
hatches.....	89, 111, 115
heat.....	262, 264, 305, 306, 347, 348
heavy lifting.....	47, 245
helmets.....	326, 327, 328
high-pressure cleaning.....	87, 184, 185
high-pressure cutting.....	185
high-pressure spraying.....	222, 243
hoisting gear.....	135, 137, 138
hoisting harness.....	302, 303
hold-down switches.....	162

holes in the floor.....	88
hollow core floors.....	295
hot work.....	305, 306, 307, 308, 309
How to protect your skin:.....	211
HSP.....	22, 24, 26, 28, 31, 33

I

If this is the case, you must use special combination equipment instead.....	331, 332
illuminated signs.....	282
immediate enforcement notices.....	13, 14
impregnated wood.....	210, 211
inclined hoists.....	153
industrial injuries..	50, 51, 53, 55, 245
industry guides.....	10
installations.....	92, 95, 96, 265, 270, 288, 298, 299
instructions for use.....	103, 178, 193
insulation.....	227, 228, 229, 256
insurance.....	52
isocyanates.....	213, 214, 215

J

jigsaws.....	175
joint fillers.....	205
joists.....	89

K

key switches.....	90, 119
Knee boards.....	79, 80
Kneeling work.....	257
Knee protectors.....	257
Knee rails.....	110, 115, 117, 122, 126, 273

L

labelling 139, 203, 228, 325, 326
 lack of oxygen 337
 ladders 64, 111, 117, 122, 129,
 130, 131, 184
 lamps 90, 91, 130
 landslides 272
 laser radiation 315
 lead 197, 221, 233, 234, 235, 236,
 287, 288
 Lead measurements 233
 lifting 134, 135, 245, 247, 249,
 251, 253, 255
 Lifting equipment 128, 142
 lifts 149, 151
 lifts intended for transporting
 persons 151
 light fittings 90
 lighting 57, 66, 90, 91
 lightweight mobile huts 72
 limit values 202, 203
 lines 125, 277, 302, 343, 345
 loading and transporting
 machines 148
 loading areas 151, 153
 load testing 138
 log book 119, 126, 137, 144
 logbook 23, 24, 27
 lung cancer 51, 221, 230
 lung diseases 211, 221
 lux 66, 91, 92

M

machine protection 181, 185
 Machinery Directive 155
 machinery for wood 165

machines 155, 156, 157, 158,
 159, 160, 161, 163, 164,
 165, 166, 169, 170
 mast work 343
 material hoist 149, 151, 152
 mental health 317, 319, 321
 metal circularsaws 169
 mineral turpentine 206
 mineral wool 227, 228, 288, 290
 mixing machines 163
 mobile cranes 138, 147
 mobile scaffolding 114, 115
 mobile workplaces 34, 40
 monotonous, repetitive
 work 259, 260
 monotonous work that places
 a strain on your body 259
 motorised hand tools 170, 171
 motor-powered chain
 saws 171, 172
 mould 244
 myoses 246

N

nail guns 180
 nasal cancer 230
 NFA 12
 nickel 348
 noise 189, 190, 191
 non-dazzle lighting 90

O

occupational illnesses 52
 offensive behaviour 319
 oilproof apron 212
 open excavations 272, 273
 order and tidiness 59

orientation lighting24, 90
oxyacetylene welding.....312
oxygen bottles.....314
oxygen cylinders 187
ozone314

P

paint 207, 208
painting.....208
particulate filters.....336
PCBs..... 22, 34, 99, 197, 221, 238,
.....239, 240, 241, 288, 290
pedestrian traffic.....58, 60, 62, 63
penalties 16
Pendulum crosscut saws 168, 169
personal protective
equipment 323, 325, 326, 331
person at bottom of ladder..... 131
personnel hoists 125, 127
personnel lifts.....128
photo-ophthalmia..... 311, 313
pile frames277
pipelines 276, 301, 304
pitched roofs 77
planing machines 165, 166
Planning involves three conditions
in particular:247, 249, 251, 253,
255, 257, 259
plugs..... 96
pole chainsaws 172
polishers.....174
powder-actuated tools
..... 177, 178, 179, 180
precast panel installation.....85, 130,
.....291, 293, 295, 297, 298
pressure-impregnated..... 210, 211
pressurised cylinders.....49, 186, 187

prevention according to the STOP
principle..... 199
prohibitions..... 13
project planning 14, 18, 23, 26,
.....237, 255
protection devices 159
protective clothing.....347
protective footwear 263, 350, 351
protective gloves237
public roads 66, 111, 120,
..... 127, 136
pulling and pushing248
pulpit 85
pushing rod..... 168

Q

Quartz dust 182, 220, 229, 230,
..... 291, 334

R

radiation 33, 313, 315, 331
rail claws 145
rail guards 145
reception culture..... 39
reflective workwear287
renovation 290, 291
replacing windows 86
reporting 15, 25, 26, 51, 52
respiratory protection with
filtration 290, 332, 333, 334,
.....337, 338
respiratory protection 332, 333,
.....334, 335, 337, 338, 339
respiratory protection with a fresh
air supply309

respiratory protection with an air supply.....	183, 224, 241, 242, 244, 274, 290, 302, 333, 337, 338
respiratory protection with filtration	211, 241
responsibilities of the employer.....	124, 197, 310, 324, 329, 348
rigger	139, 140, 141
rigging gear	139, 140, 142, 143
risk of fire	306
risk of poisoning	315
ripping knife.....	167, 168, 176
Roads.....	58, 62, 95
roadworks	267, 278, 279, 280, 283, 284, 285, 286, 348
roll-over protective cab.....	148
roofing.....	77, 79
roofing felt work.....	64
roof ladders.....	78
roof pointing	213
roof spaces.....	64, 229, 256, 299, 300, 301
run-on.....	163

S

sack trolleys.....	253
sack trucks.....	63
safety footwear.....	182, 289
safety glasses	179
safety glasses	172
safety goggles.....	228
safety information leaflets.....	198
safety meetings	18, 19, 24, 30, 40, 41
safety nets	60, 61, 83, 84
sandblasting	87, 181, 183, 184
scaffolding.....	32, 57, 60, 61, 103, 104, 105, 106, 108, 110, 111, 113
scrapers.....	148
screening.....	77, 110, 123, 169, 225, 311
screens	110, 122
shared areas.....	24, 25, 32
Sheathed cables	95
shelters.....	100
shoring.....	283, 292, 294, 295, 296
Shoring box.....	269
showers.....	67, 68, 70, 72, 218, 226, 236, 238, 240, 243
silicosis.....	183, 230
single-use masks.....	290, 334, 338
site hut facilities.....	73
site huts.....	64, 66, 69
site huts.....	58, 65, 66
skin cancer.....	348, 349
skin care	212
skin damage	315
skylights	89
smoke	159, 197, 198, 202, 216, 217
snow clearance.....	24, 27, 58
Soil contaminated with chemicals.....	236, 237
soil contaminated with oil and chemicals.....	236
soldering.....	305
Soldering	315
solvents	211, 216, 217, 218, 307, 309, 324, 328, 336, 348
spray mist	206, 207, 212
spray painting.....	207
spray prohibition.....	213
stairs	61, 64, 108, 247, 252
stair towers.....	61
standing work.....	350
steep slopes	267

stress318
 subsidiary switchboards 92
 substitution..... 199, 256
 supervision..... 11, 20
 supervisors 20, 41, 42, 43, 325
 supplementary working
 environment training..... 43
 suppliers..... 21
 support legs..... 114, 127, 147, 153
 switches 96

T

table saws 166
 technical equipment 260, 261
 telescopic loaders ..63, 125, 135, 136
 temporary roads 63
 tendonitis 246
 that a working environment
 coordinator is appointed..... 24, 26,
 27, 28, 29
 thatching bridges..... 83
 The Danish Labour and
 Employment Ministry..... 11
 The Danish Working Environment
 Appeals Board..... 11, 15
 the effect of chemicals..... 197
 The National Research Centre for
 the Working Environment (NFA).... 12
 thermal clothing..... 347
 the Smiley system 18
 The Working Environment
 Act 9, 10
 The Working Environment
 Authority..... 10, 11, 12, 13, 14,
 15, 16, 17, 18, 25, 34, 43, 45
 the Working Environment
 Council..... 11

thinner..... 208
 This assessment must be
 presented in writing..... 197, 221,
 222, 223, 225, 227
 This risk can be divided into four
 areas: 326, 327
 thread cutting 170
 thread cutting machines 169, 170
 tidiness 57, 59
 TIG welding..... 313
 time pressure 317
 to check for steep slopes..... 144, 145
 to check the emergency stop..... 144,
 153
 to check the end
 stop 144, 145, 146
 toilets 67, 71
 toluene 335
 Tools 170, 171, 172, 173, 175
 tower cranes.134, 135, 143, 145, 147
 toxic substances..... 204, 205
 transmission masts 113
 transport machinery 148, 149
 transport platforms..... 149, 150, 151
 traumatic events..... 318
 trestle scaffolding..... 116, 117, 118
 trousers 172
 truck-mounted cranes 135, 138
 turbo respiratory protection 337
 turpentine 206
 two-coloured..... 97

U

undergloves 348
 unhooking prevention 143
 Uprights..... 268, 269, 331
 urea salt..... 100

V

vacuum cleaner	220
vertical ladders.....	302
vibrating sanding machines	174
vibration.....	191, 192, 193, 194, 195
vibrators	165
viruses	334, 336, 349

W

walkways.....	58, 63, 83
wall panels	296
wallpaper removal.....	210
warning lights.....	282
warning strips.....	94
waste.....	28, 59, 60, 61, 99, 201, 225, 236
waste water	242
water pipes	98
webbing	139, 143, 186
weight limits	249, 255
welding	309, 311, 313, 314
welding gloves	312
welding helmets.....	311
welding light.....	311
welding smoke.....	198, 202, 231, 309
welfare arrangements	32, 68
welfare facilities.....	215, 239
well-being	321
wells	301, 302, 303, 305
wet sandblasting	184
when different genders share site huts.....	73
white fingers.....	185, 191, 193
wind strength.....	212
winter measures	99, 100, 101, 121
wood dust	220, 230, 231

woodworking machines.....	165
workbenches	253
working environment advisor	14, 34, 193, 195, 202, 203, 234
working environment organisations.....	12, 34, 35, 37, 38, 39, 41, 42, 43, 44
working environment representative	37, 39, 41, 42, 43
working environment training	43
working height.....	111, 117, 165, 258
working in a set position	256
working in wells	302, 303
working lights.....	90, 91
working temperature	101
work pace.....	260
workplace assessment	46, 47
work platforms.....	118, 119, 120, 121, 122, 123
WPA.....	46, 47, 48, 49, 53, 55, 311

X

xylene.....	206
-------------	-----

Y

young people.....	48, 49, 50
-------------------	------------

